INDICE

AERMACCHI	3	MINARELLI	77
AERMACCHI H.D.	5	MI-VAL	79
ALPINO	9	MONDIAL	79
AMAL	9	MORINI	79
APRILIA	11	MOSQUITO	81
ARCES	13	MOTOBI	83
ARIEL	13	MOTOM	83
BARTALI	13	MV	85
BENELLI	13	MZ	87
BETA	17	NSU	87
BIANCHI	17	PARILLA	87
BINKS	19	PUCH	89
BSA	19	RUMI	89
BSA-TRIUMPH	19	SERTUM	91
BMW	21	STERZI	91
CAGIVA	23	SUZUKI	91
CAPRIOLO	25		
CECCATO	27	VESPA	93
DEMM	27	PIAGGIO	111
DKW	27	APE	129
DUCATI	29		
FANTIC	35	YAMAHA	133
GABBIANO	35	ZÜNDAPP	135
GARELLI	35		
GILERA	37	MANOPOLE STANDARD	137
GITAN	41	APPOGGIAPIEDI	141
GRIMECA	41	COPRILEVA	143
GUZZI	43	SOFFIETTI STANDARD	147
HONDA	53	TIRANTI	153
ISO	55	CAPPUCCI CANDELA	155
KAWASAKI	57	GUIDA CATENA	155
KREIDLER	57	SILENT BLOCK	155
LAMBRETTA	59	CAPPUCCI	156
LAMBRO	69	VARI	157
LAVERDA	69	MANICOTTI SCARICO	161
MAICO	73	MANICOTTI CARBURATORE	163
MALAGUTI	75	PARAOLIO MOTORE	167
MALANCA	75	KITS PARAOLIO	173
MARZOCCHI	77	O-RING	181
MATCHLESS	77	TUBO BENZINA	183

<i>Articolo</i>	<i>Descrizione</i>	<i>Simile al Nr. Orig.</i>
00653/A	Paio Manopole 125 Cc Diam.22/24	
00653/B	Paio Manopole Diam.24/24 Per Modelli con Cambio al Manubrio - Cigno, Ghibli, Zeffiro	
00664/65/A	Paio Manopole 175-250 Cc. Diam.22-24	
00830	Parastrappi Ruota Aermacchi 125 20x10x6,5	
00930	Anello Di Guarnizione Per Tubo Flessibile	
01525/A	Paio Copripedale Guidatore In Gomma Dx E Sx	
01527/A	Appoggiapiedi A Scatto Passeggero 175-250	
01531/A	Coprileva Selettore Cambio 175-250	
01575/A	Coprileva Cambio 250 Cc. Ala Rossa	
01804	Parastrappi Ruota Posteriore 125/U 1955 2 Tempi	
04905	Soffietto a 15 Spire, Diam.48/48 mm. Lungh. 190 - 350 GT/GTS	
04994	Cappuccio Protezione Interruttore Stop	14352
04995	Cappuccio Interruttore Luce Stop MIs 125/70	11293
04996	Manicotto Elastico Dado Perno Sterzo	11904
04997	Guarnizione Ritegno Benzina Ala D'Oro	
04998	Passacavo Guarnizione Bobina	9000
05912	Cappuccio Conico Protez. Carburatore Ala Verde-Blu Gt-250	
05915	Giunto Per Carburatore 350 Gt	
05925	Spessore Appoggio Serbatoio	6969
05926	Cuscinetto Elastico Anteriore Serbatoio	9412
05927	Sostegno Attacco Anteriore Serbatoio	8008
05932	Manicotto Carburatore	8900
05936	Supporto Catarifrangente Forcelle Ant. 350 Ss/71-MIs 125/71	10250
05938	Tampone Fine Corsa Leva Avviamento 125 Cc.	9445
05939	Tampone Supporto Cabina	
05942	Tampone Sospensione Anteriore	



☆ 04905



★ 00653/A
00653/B



★ 00930



★ 00664/65/A



★ 01525/A



★ 01527/A



01575/A



★ 04994



★ 04995



★ 04996



★ 05942



★ 01531/A



★ 05912



★ 05925



★ 05938



★ 05926



★ 05932



★ 05915



★ 04997



★ 04998



★ 05939



★ 05936



★ 05927



★ 01804



★ 00830

<i>Articolo</i>	<i>Descrizione</i>	<i>Simile al Nr. Orig.</i>
00837	Parastrappi Ruota Posteriore 175 - 175S - 250 - 250N	
05937	Cappuccio Estremita' Cavi	75777
05945	Guarnizione Tappo Serbatoio Diam. 37,5x45x2	7547
05946	Guarnizione Tappo Serbatoio Diam. 40x56x2	2964
05963	Tampone Elastico Per Supporto Manubrio	8831
05963/A	Tampone Elastico Per Supp. Manubrio Sh.80	19400
05964	Soffietto Per Cornetto Presa Aria 125 Cc. Regolarita`	16333
05970	Cuffia Protezione Cavi Int. Accensione Sx 175/74 E 250 Cc.	21651
05974	Manicotto Aspirazione Diam. 47 Mm.- Sx 250/74	20492
05978	Manicotto Aspirazione Diam. 39 - Sx 250/74	20355
05981	Passacavo Condotti Olio - 175 - 1c - 2t	19618
05982	Calotta Forcella Diam. 27 Mm. - Mc 90/73	18691
05985	Protezione Batteria M 90/73 - Mls 125/73	18385
05986	Tappo Foro Controllo Messa In Fase Sx 350/73	18201
05987	Gommino H. 50 Mm. Squad. Fiss. Batteria M 90/73-Mls 125/73	18170
05987/A	Gommino H.30 Mm.Tenuta Laterale Batteria M 90/73-Mls 125/73	18169
05987/B	Gommino H.25 Mm. Appoggio Inferiore Batteria 90 E 125 Cc.	18168
05988	Manicotto Silenziatore Aspirazione Mls 125/73	18028
05989	Tampone Ancoraggio Anteriore Serbatoio Benzina Mls 125/73	
05990	Tappo Sfiato Olio Mc 90 - M 90 - Mls 125 - Msr 100/73	17692



☆ 05945



☆ 05946



☆ 00837



☆ 05981



☆ 05964



☆ 05974



☆ 05978



☆ 05982



☆ 05970



☆ 05988



☆ 05963
05963/A



☆ 05986



☆ 05987/A



☆ 05987



☆ 05987/B



☆ 05989



☆ 05985



☆ 05990



☆ 05937

<i>Articolo</i>	<i>Descrizione</i>	<i>Simile al Nr. Orig.</i>
00587	Copripedale Leva Cambio 125 Cc.	
00664/65	Paio Manopole 175-250 Cc Diam.22/24 (Marchio Aermacchi Harley Davidson)	
00664/65/H	Paio Manopole 175-250 Cc. - Diam. 22/24 (Marchio Harley Davidson)	
00680/A/H	Paio Manopole Neoprene Diam.22-24 Lungh. 127 Mm.	
00680/H	Paio Manopole Per Wisconsin Diam.22-24 Lungh.117	
00825	Parastrappi Ruota Posteriore 125 Cc.	
01518	Coprileva Avviamento 125 Cc. Foro Diam.13 Lungh.38	
01525	Paio Copripedali Guidatore Dx-Sx Per Chimera 175 Cc	
01527/H	Appoggiapiedi A Scatto Per Passeggero 175-250 Cc.	
01531	Coprileva Cambio 175-250 Cc Diam. 9 Lungh. 42 (Marchio Aermacchi Harley Davidson)	
01531/H	Coprileva Cambio 175-250 Cc. Diam.9 Lungh. 42 (Marchio Harley Davidson)	
01553	Coprileva Avviamento - Lunghezza 61 Mm. (Marchio Aermacchi Harley Davidson)	4362
01553/H	Copripedale Avviamento - Lunghezza 61 Mm. (Marchio Harley Davidson)	4281
01553/HL	Copripedale Avviamento - Lunghezza 72 Mm. (Marchio Harley Davidson)	11484
01555/H	Copripedale Guidatore Wisconsin 250/H Foro Diam.38	
01574	Copripedale Guidatore (Marchio Aermacchi Harley Davidson)	7058
01574/H	Copripedale Guidatore (Marchio Harley Davidson)	7058
01575	Coprileva Freno E Cambio Diam.9 Mm. 250 Ala Rossa (Marchio Aermacchi Harley Davidson)	
01575/H	Coprileva Freno E Cambio 250 Cc. (Marchio Harley Davidson)	
01577	Coprileva Avviamento Diam. 9 Mm. (Marchio Aermacchi Harley Davidson)	6412
01577/H	Coprileva Avviamento Diam. 11 Mm. (Marchio Harley Davidson)	7062
01817	Parastrappi Ruota Posteriore 250 - 250 N	
01820	Parastrappi Mozzi Salvai - Amf	
01844	Parastrappi 350 Cc. 4t	11874
01846	Parastrappi 125 Sxt -> '81 - 125 Sst -> '83	12434
01848	Parastrappi Mozzo Grimeca Aletta 125 Regolarita'	621107792
01851	Guarnizione Tappo Serbatoio Benzina Diam.57x42x3	
03963	Guarnizione Tappo Serbatoio	
03984	Cappuccio Presa Corrente Fanale Posteriore 250 Cc.	4086
03985	Tampone Attacco Anteriore Serbatoio Benzina 175-250 Cc.	
03986	Tampone Attacco Posteriore Serbatoio Benzina 175-250 Cc.	
03993	Tampone Coperchio Protezione Catena 175-250 Cc.	
05913	Tampone Ammortizzatore	4783
05914	Tampone Sospensione Posteriore	28330



★ 01555/H



★ 00680/A/H
00680/H



★ 01574
01574/H



★ 00664/65
00664/65/H



★ 01525



★ 01527/H



★ 01575
01575/H



★ 00587



★ 01577
01577/H



★ 01531
01531/H



★ 01518



★ 05913



★ 05914



★ 00825



★ 01553
01553/H
01553/HL



★ 01817



★ 03986



★ 01844



★ 03984



★ 01820



★ 01846



★ 03963



★ 01851



★ 01848



★ 03985



★ 03993

<i>Articolo</i>	<i>Descrizione</i>	<i>Simile al Nr. Orig.</i>
05924	Tampone Appoggio Serbatoio	7912
05928	Tampone Appoggio Serbatoio	9032
05929	Tampone Appoggio Serbatoio	8236
05940	Passacavo	7652
05983	Tampone Serbatoio	18555
06960/A	Racc. Carburatore Diam. 35 - 350 Cc 2c 2t Corsa Per Mikuni	28852
06960/B	Manicotto Carburatore Diam.38-250/350 Corsa Mikuni	
06960/C	Manicotto Carburatore Diam.36 - 250/350 Corsa -	

ALPINO

<i>Articolo</i>	<i>Descrizione</i>	<i>Simile al Nr. Orig.</i>
00572	Copripedale Guidatore Diam. 13	
00580	Coprileva Selettore Cambio	
00637	Paio Manopole Diam. 22-24 (Marchio Alpino)	
00637/A	Paio Manopole Diam. 24-24 Per Modello con Micromotore	
02813	Cuscinetto Per Ammortizzatore	90307
02814	Rondella Per Tubo Porta-Fanale Diam.36x25	90463
02814/A	Rondella Per Tubo Porta-Fanale Diam.36x30	
05862	Distanziale Per Tirante 175 Cc. 4 Tempi	
05863	Copertura Di Tenuta Per Dado Presa Diretta	

AMAL

<i>Articolo</i>	<i>Descrizione</i>	<i>Simile al Nr. Orig.</i>
09991	Manicotto Carb.Amal Serie 2900 Foro Passaggio 34 Mm	
09998	Manicotto Carburatore Amal Diam.28 Mm.	
09999	Manicotto Carburatore Amal Diam. 40 Mm.	



05924



05929



05928



05940



05983



★ 06960/A



★ 06960/B



★ 06960/C

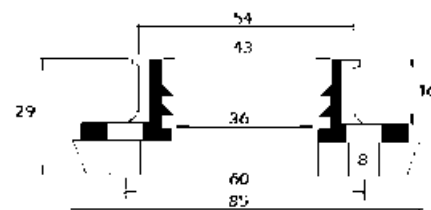
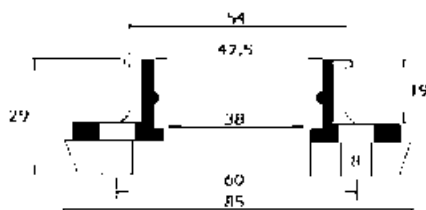
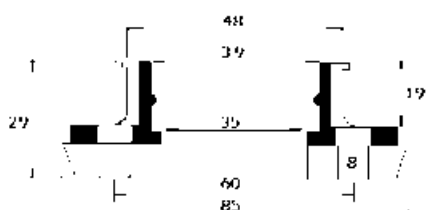

ALPINO



★ 00572



★ 00580



★ 02813



★ 05862



★ 00637
00637/A



★ 02814



★ 02814/A



★ 05863

AMAL



09991



09998



09999

<i>Articolo</i>	<i>Descrizione</i>	<i>Simile al Nr. Orig.</i>
00914/D	Manicotto Marmitta	8200003
00922	Cappuccio A Pipa	8120218
01582	Coprileva Cambio	8420007
01584	Coprileva Cambio	8220189
02519	Coprileva Cambio	8220276
03935	Cappuccio	8120482
04958/A	Soffietтино Cavi	8120409
05916	Manicotto Marmitta	8120375
05924	Tampone Appoggio Serbatoio	8420003
05928	Tampone	8120001
05931/A	Cappuccio	8220135
05940	Passacavo	8120405
05989/A	Tampone Ancoraggio Serbatoio	8120221
05996	Rondella	8120276
06919	Gommino Cavalletto	8120455
06945/A	Pattino Tendicatena	8101736
06958/A	Anello Elastico	8120272
06963/A	Silentblock	8120402
06975	Manicotto Marmitta	8101319
07904	Gommino Cavalletto	8120220
07946	Gommino Cavalletto	8120857
08986/A	Silentblock	8201121
08998	Supporto Ammortizzatore	8120249
09949	Passacavo	8120030
09992	Manicotto Marmitta	8220297
10937	Manicotto Carburatore Aprilia-Peugeot Scooter	8206118
10949	Tampone Ritorno Cavalletto Amico 50 - Sr - Scarabeo	8220239
12934	Manicotto Aspirazione Leonardo 125-150 96-2004	8120888



06958/A



02519



01852



01584



05916



06975



00914/D



09992



05931/A



★ 07946



05924



10949



03935



09949



05940



05996



05989/A



08998



07904



05928



06919



08986/A



06963/A



06945/A



00922



04958/A



10937



12934

<i>Articolo</i>	<i>Descrizione</i>	<i>Simile al Nr. Orig.</i>
04975	Calotta Forcella Diam.30 Arces-Ceriani	
04975/A	Calotta Forcella Diam.32 Arces-Ceriani	
04990	Calotta Forcella Diam.30 Tipo Arces-Ceriani	
04991	Calotta Forcella Diam.35 Tipo Arces-Ceriani	
06903	Calotta Forcella Diam.35 Tipo Arces-Ceriani	
06903/A	Calotta Forcella Diam.35 Con Asola Tipo Arces-Ceriani	
06904	Calotta Forcella Diam.38 Tipo Arces-Ceriani	

ARIEL

<i>Articolo</i>	<i>Descrizione</i>	<i>Simile al Nr. Orig.</i>
00527	Coprileva Passeggero Foro Rettangolare	

BARTALI

<i>Articolo</i>	<i>Descrizione</i>	<i>Simile al Nr. Orig.</i>
00506/B	Copripedale Guidatore Foro Cieco 14	

BENELLI

<i>Articolo</i>	<i>Descrizione</i>	<i>Simile al Nr. Orig.</i>
00407/08	Paio Ginocchiere Dx E Sx	
00541	Copripedale Guidatore 250 Cc.	
00595	Coprileva Cambio 125-150 Cc.	



★ 04975



★ 04975/A



★ 04990



★ 04991



★ 06903



★ 06903/A



★ 06904



★ 00527



★ 00506/B



★ 00407/08



★ 00541



★ 00595

<i>Articolo</i>	<i>Descrizione</i>	<i>Simile al Nr. Orig.</i>
00520	Copripedale Guidatore	
00685	Paio Manopole Neoprene Diam. 22/24 - 125-250 Ss	
00909	Giunto Elastico Per Magnete Foro Diam.25	
00910	Giunto Elastico Per Magnete Foro Diam.35	
01591	Copripedale Guidatore Lungh.94 Foro Cieco A Sezione Ovale	
02508	Tappeto Per Telaio Bobo 50 Cc.	N253
02512	Tappeto Chiu'	4040060799
03933	Boccola Per Ammortizzatore Posteriore Diam. 24x14x16	
05859	Anello Di Tenuta Olio Albero Messa In Moto 125cc.(18,5x15x7)	
06917	Copridado Diametro 19 Anteriore 125 - 250 Cc.	20Z3297
06918	Copridado Posteriore 125 - 250 Cc. Diam. 21 Mm	20Z3298
06918/A	Copri Dado Esagono 23 Mm	2880730799
06964	Passacavo Ovale Per Borsette 125-250 2c	39461600
07909	Tampone Sospensione Posteriore Serbatoio 50 Cross	93180581
07914	Passacavo Borsette Laterali E Sella 2 T 50 Cc. 5v Turismo	91551104
07916	Passacavo Antivibrante Vari Usi 650 Cc 4 T	91551082
07928	Supporto Fanalino	17ES3038
07929	Sostegno Antivibrante Intermittenza 650 4 T Es	17751200



★ 02508



★ 02512



★ 00685



★ 06918

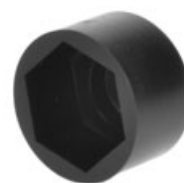

★ 06918/A



★ 00520



★ 01591



★ 07909



★ 07914



★ 07916



★ 05859



★ 03933



★ 06964



★ 06917



★ 00909



★ 00910



★ 07928



★ 07929

<i>Articolo</i>	<i>Descrizione</i>	<i>Simile al Nr. Orig.</i>
00539/B	Coprileva Cambio Diam. 11 Mm.	
01520	Copripedale Guidatore Foro Diam. 10 Mm	

BIANCHI

<i>Articolo</i>	<i>Descrizione</i>	<i>Simile al Nr. Orig.</i>
00509	Copripedale Guidatore Foro Cieco 14 - 125Cc. - 175 Cc.	73482
00519	Paio Copripedali Guidatore 250-500 Cc.	3077
00588	Copripedale Passeggero Foro Quadro 175 Cc. Cervino / Pordoi - 125 Cc. Mendola	75958
00612/12/A	Paio Manopole 500 Cc Diam 24/27 - Grigio	
00612/A-N	Paio Manopole 500 Cc Diam 24/27 - Nere	22139
00614/14/A	Paio Manopole Foro Passante 125 Cc Diam.22/24	73867 / 73868
01508	Coprileva Avviamento Diam. 11 - 175 Cc. Cervino / Pordoi	85148
01538	Copripedale Guidatore Foro 14 - Mendola	H 13482
01996	Sostegno Motore Aquilotto	



★ 01520



★ 00539/B

BIANCHI



★ 00519



★ 00509



★ 00588



★ 00612/A-N



★ 01538

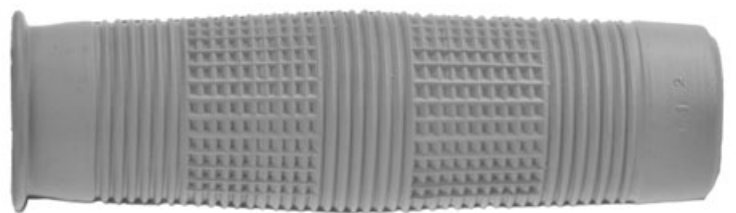

★ 00612/12/A

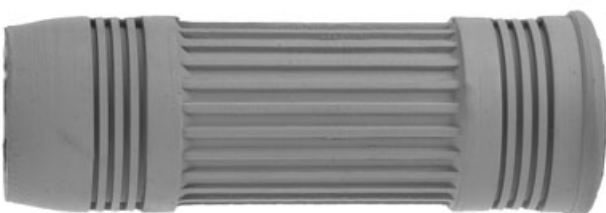

★ 00614/14/A



★ 01508



★ 01996

<i>Articolo</i>	<i>Descrizione</i>	<i>Simile al Nr. Orig.</i>
00606	Paio Manopole	
00606/7	Paio Manopole Binks Pvc Foro Cieco Diam. 22/24	
00606/7A	Paio Manopole Binks In Pvc Con Anello Paramano Diam. 22/24	
00606/7-GR	Paio Manopole Binks Foro Cieco Diam. 22/24 - Grigio	
00608/A	Manopola Tipo Binks Diam. 24	
00609	Manopola Tipo Binks Diam. 27	

BSA

<i>Articolo</i>	<i>Descrizione</i>	<i>Simile al Nr. Orig.</i>
02527	Copripedale Passeggero Foro Cieco Quadro 20 X 20 Lungh.110	
02528	Copripedale Guidatore Foro Cieco Rett. 18 X 11 Lungh.118	
04982	Soffietto Forcella Bsa/Bantam Diam.22/26 5 Spire Lungh.160 - D1-D3-D5 dal 48 al 58	

BSA - TRIUMPH

<i>Articolo</i>	<i>Descrizione</i>	<i>Simile al Nr. Orig.</i>
00403/04	Paio Ginocchiere Dx E Sx Marchio Triumph	
00523	Copripedale Guidatore	
05954	Soffietto Forcella Diam.50/55 Lungh.215 Bsa-Triumph	
05955	Soffietto Forcella Diam.30/40 Lungh.150 Triumph	
05956	Soffietto Forcella Diam.50/50 Lungh.150 Triumph	



☆ 00606

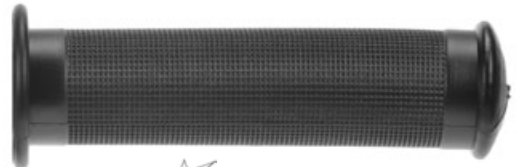

☆ 00606/7



☆ 00608/A

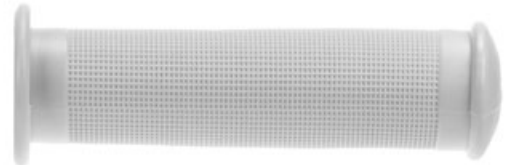

☆ 00606/7-GR



☆ 00606/7A



☆ 00609

BSA



☆ 02527



☆ 02528



☆ 04982

BSA - TRIUMPH



☆ 05954



☆ 05955



☆ 05956



☆ 00403/04



☆ 00523

<i>Articolo</i>	<i>Descrizione</i>	<i>Simile al Nr. Orig.</i>
01594	Copripedale Guidatore	46711234660
01595	Coprileva Cambio	
01616	Paio Manopole in Spugna	
01690/F	Paio Manopole 22/24 (Forate)	32721458395 DX - 3272145839 SX
01690/F/24	Paio Manopole 26-26 Per Comandi Riscaldati	
02541	Pedana K 75/100 1983-84-85	467 11451 982
02624/C	Paio Manopole 26-26 Per Comandi Riscaldati Fondello Chiuso	
02624/L	Paio Manopole 26-26 Per Comandi Riscaldati Dal 2009 Lunghezza 125 Mm	
06905	Soffietto Forcella - R75/5	31421234908
06906	Paraolio Tubo Asta-Valvole	11110033163
06991	Soffietto Forcella - R 51	UA309625
08904	Soffietto Forcella F 650	
09974	Paio Soffietti Forcella K100	
10998	Paraolio Pinza Freno 40 Mm Ate	34111233317
10999	Guarnizione H=3 Interno Pinza Freni Ate 40 Mm	
10999/A	Guarnizione H= 3 Mm Interno Pinza Freni Ate 38	
11902	Silentblock Porta Batteria Bmw	61211233028
11904	Cappuccio Spurgo Pompa Freno Brembo - Confezione Da 20 Pezzi	
11919	Silentblock Piastra Diodi Bmw	12311358131
11935	Profilo per Contatto Cavità Freno Serie R (confez. 25 Metri)	11141262644
12918	Paraolio Pistone Frizione Bmw Tutti I Modelli Dal 1955-1980	2152020109
Articoli Non Figurati		
ARI.003T	Kit Paraolio Forcella Dcy 35 X 48 X 11	
ARI.023	Kit Paraolio Forcella Tcy 40 X 52/52,7 X 10/10,5	31421458064
ARI.028	Kit Paraolio Forcella Tcl 41,7 X 55 X 7,5/1	
ARI.042	Kit Paraolio Forcella Rii Serie Monoshock Fino Al 1985	31422310199
ARI.043	Kit Paraolio Forcella R I Serie Dal 1970 Al 1984	31421230001
ARI.045	Kit Paraolio Forcella K 16v. Dal 1990	31421450127
ARI.047	Kit Paraolio Forcella F 650 Dal 1994 - R100r	31422312838
ARI.083	Kit Paraolio Forcella Dc4y 41,7 X 55 X 7,5/10	31422312928
ARI.084	Kit Paraolio Forcella R 2 Cilindri 2 Valvole Dal 1985	31422310199
P/092	Paraolio Sc 32 X 20 X 7	11111262977
P/194	Paraolio Sc 47 X 28 X 7	11141255011
P/268	Paraolio Sc 100 X 80 X 10	11111261739
P/338	Paraolio Scr 40 X 26,5 X 9 Albero Cambio R2 5 Marce Dal 1984	23121338726
P/347	Paraolio Hscr 32 X 20 X 7 In Silicone (Motore)	
P/348	Paraolio Hscr 47 X 28 X 7 (Motore)	
P/349	Paraolio Hscr 25 X 12 X 8 In Silicone (Motore)	
P/350	Paraolio Hscl 100 X 78 X 10 In Silicone (Motore)	
P/356	Paraolio Sc 70 X 40 X 7,5	23121232681
P/357	Paraolio Sc 85 X 65 X 10,5	33123004343
P/358	Paraolio Tc 25 X 12 X 7	11141261193
P/359	Paraolio Tc 28 X 17 X 7/6	



01690/F
01690/F/24



02624/L
02624/C

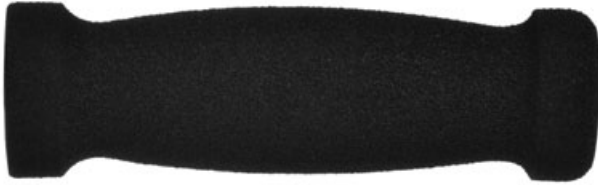

01616



02541



11935



★ 01594



★ 01595



★ 06906



11904



10998



10999/A



10999



12918



11902



11919



★ 06905



★ 06991

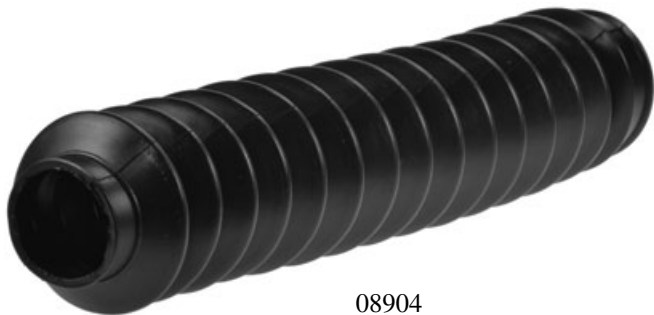

08904



09974

<i>Articolo</i>	<i>Descrizione</i>	<i>Simile al Nr. Orig.</i>
00921	Cappuccio A Pipa	800040923
00922	Cappuccio A Pipa	800063496
00923	Cappuccio A Pipa	800040922
00927	Passacavo	60N023028
00950	Passacavo Commutatore	800023029
00972	Tappo Protezione Nero	80A058394
00972/A	Tappo	800072202
01661/SSF	Paio Manopole	
01909	Tampone Parafango	800023962
02533	Copripedale Freccia C9-12-Paso 750	37069940
02943	Passacavo	800034888
04901	Tappo Depuratore	800039030
04947	Passacavo	800041862
04975	Calotta Forcella Arces-Ceriani Stelo Diam. 30	
04999	Cappuccio Candela In Silicene	800023158
04999/L	Cappuccio Candela In Silicene	800051139
05914	Tampone Sospensione	800028330
05916/C	Manicotto Marmitta	800037884
05918	Gommino Appoggio Inferiore Targa	800066308
05924	Manicotto	800007912
05962	Anello Passacavo	800033056
05996/A	Rondella 16 X 5 X 1,5	800037656
06910	Passacavo Radiatore	
06958	Anello Elastico	800029868
06958/A	Anello Elastico	
06975	Manicotto Marmitta	800031632
06996/B	Rullo Guidacatena	800033470
07938	Pipetta	800025989
07998	Tirante Con Asola	800031981
08978	Cappuccio	800052347
09949	Passacavo	800018048
10928	Cappuccio Passacavo	800021615



00921



00922



00923



07938



04999



04999/L



05916/C



06975



10928



09949



04947



00927



★ 00950



05924



04901



★ 06910



02943



★ 05914



05996/A



★ 01909



06996/B



★ 00972/A



05918



★ 00972



08978



05962



07998



06958/A
06958



★ 04975



02533



01661/SSF

<i>Articolo</i>	<i>Descrizione</i>	<i>Simile al Nr. Orig.</i>
00850	Parastrappi Capriolo 125 Cc - Diam. 23 X 11 Foro 6,5 Decentrato	
00999	Soffietto Forcella Capriolo 75 Cc Dal 1951 Diam. 29/30 Lungh. 170	
01506	Copripedale Guidatore Foro Diam 14 Capriolo 125 Gt Dal 1958	
01506/A	Copripedale Guidatore Foro Diam. 12 Capriolo 75 Dal 1951	
01506/B	Copripedale Guidatore 75 Aeromere Foro Rettangolare 24 X 5 Dal 1958	
01545/A	Paio Copripedali Guidatore Dx + Sx - 100 Cc Bondone	
01998	Boccola Per Arresto Messa In Moto	
03905	Boccola Guida Canotto Forcella 125 Cc	
03930	Blocchetto Per Gruppo Portatarga 125 Cc	
03940	Passacavo Isolante Cavo Lato Volano	
03941	Passacavo Volano	



☆ 00850



☆ 03940



☆ 03941



☆ 03905



☆ 01998



☆ 01506/A



☆ 01506/B



☆ 01545/A



☆ 01506



☆ 00999



☆ 03930

<i>Articolo</i>	<i>Descrizione</i>	<i>Simile al Nr. Orig.</i>
00606/7	Paio Manopole Diam. 22-24	
00662	Paio Manopole 22-24 Marchio Ceccato	
01505	Copripedale Guidatore Foro Diam.14	
01517	Copripedale Guidatore Foro Diam. 12 - 14 - 16 (Specificare Diam.)	
01528	Coprileva Avviamento Foro Passante Diam.11 Lungh.62	
01529	Coprileva Cambio Foro Diam.9 Lungh.51	
01530	Coprileva Cambio Foro Diam.11 Lungh.30	
02891	Guarnizione Paraolio Motore Lato Volano	
04851	Paraolio Forcella Marzocchi Diam. 30	
04852	Paraolio Forcella Marzocchi Diam.35	

DEMM

<i>Articolo</i>	<i>Descrizione</i>	<i>Simile al Nr. Orig.</i>
00594	Copripedale Guidatore Foro 14	
01819	Parastrappi	
02968	Boccola Attacco Motore	
03947	Tampone Frizione Velomatic	
04944	Tampone Frizione Velomatic	

DKW

<i>Articolo</i>	<i>Descrizione</i>	<i>Simile al Nr. Orig.</i>
00413/14	Paio Ginocchiere Dkw Modelli NZ dal 1938, Modelli RT dal 1949	172207
00549	Pedana Guidatore Modelli SB dal 1933 - Diam. 15 mm.	
00571	Pedana Guidatore Modelli NZ dal 1938 - Diam. 18 mm.	
00697	Paio Manopole Magura Per Ciclomotori - Dkw Mofas Tutti I Modelli	
08934	Soffietto Forcella Dkw 200-250 Cc Fino Al 1955	
08935	Soffietto Forcella Dkw 250-350 Cc Dal 1955	
08936	Soffietto Forcella Dkw Hummel Ts De Luxe Dal 1963	



☆ 00571



☆ 00549



★ 01505



★ 01517



★ 00606/7



★ 00662



★ 01528



★ 01529



★ 01530



★ 02891



★ 04851



★ 04852

DEMM



★ 00594



★ 02968



★ 03947



★ 04944



★ 01819

DKW



★ 00413/14



★ 00697



★ 08935



★ 08936



★ 08934

<i>Articolo</i>	<i>Descrizione</i>	<i>Simile al Nr. Orig.</i>
00501	Copripedale Guidatore 60 Cc.	
00506/A	Copripedale Guidatore 98 Cc. - Foro Diam. 18 Mm. Dal 1952 Al 1962	
00510	Coprileva Cambio	
00557	Coprileva Avviamento	M300121
00569	Coprileva Cambio 60 Cc.	
00570	Coprileva Cambio-Freno 60 Cc.	
00591	Copripedale Guidatore In Gomma 65t-TI - Foro Rettangolare	
00626/26/A	Paio Manopole Diam.21/23	
00840	Parastrappi Ruota Posteriore 98 Cc. Sport	
00861	Paraolio Forcella Marzocchi Ducati Sport 85-125	
00918	Soffietto Sospensione Posteriore 48 Cc.	
01510	Coprileva Cambio 98 Cc. Foro Rettangolare Lungh.56	
01535	Coprileva Cambio	9007320
01539	Coprip.Guid. 100 Sport - 125 Sport Dal 1957 -125ts 1961/1965 160 Monza Junior 1966 - 175 Dal 1958 - 200 Elite 1959/1965 250 Mach 1 1963/1966 - Mark 3250/350/450 Dal 1965	044069
01572	Coprileva Guidatore	68969110
01582	Coprileva	32513553
01589	Coprileva	75507350
01843	Parastrappi A Stella Mozzi Grimeca Diam.179 Spessore 20 Mm.	079580230



<i>Articolo</i>	<i>Descrizione</i>	<i>Simile al Nr. Orig.</i>
00921	Cappuccio	46038030
00927	Passacavo	002381055/3
01809	Parastrappi Campagnolo Ducati	
03901/A	Boccola 18,5 X 14,5 X 16,5	70010081A
03912/A	Soffietto Raccordo Carburatore/Filtro	069291110
03988	Cinghia Batteria	69891903
04914/A	Soffietto Aspirazione 750 - 750 Gt - 19 Spire	
04914/B	Soffietto Aspirazione Tagliato A 15 Spire - Imb. 39 Mm	
04947	Passacavo	79772068
05855	O.Ring Passaggio Olio Fra Cilindro E Testa 100-125-175 Cc.	
05924	Silentblock	37084180
05930	Flangia Dia. 25,5	
05930/A	Flangia Diam. 28,5	060192270/1
05930/D	Flangia Diam. 32	
05962	Passacavo Ad Anello	79791070
05983	Tampone	79783030
05996	Rondella	079585060/1
06875/S	Guarnizione Stelo Valvole - Silicone Neutro	
06875/V	Gommino Viton Per Valvola	76410091A
08928	Tirante Serbatoio Pantah	0066083175
09949	Passacavo	36198690
10909	Passacavo	36191730
10957	Gommino Valvole Ducati In Viton Nero	76410131A
10958	Gommino Valvole In Viton Nero	76410092A
12919	Rondella Passacavo	068983040/1
12920	Tappo	0609922235



10909



★ 03901/A



10958



06875/V
06875/S



10957



04947



09949



★ 12919



00927



★ 12920



★ 05855



05996



05924



05962



00921



05983



★ 05930/A
05930/D



★ 05930



★ 01809



08928



03988



★ 04914/B



03912/A



★ 04914/A

<i>Articolo</i>	<i>Descrizione</i>	<i>Simile al Nr. Orig.</i>
04983	Soffietto Forcella	68937310
06934	Supporto Antivibrante Strumenti Scrambler	069037050
06934/A	Supporto Contagiri/Km - Interasse Fori Attacco 170 Mm	069637050
06953	Manicotto Carburatore Diam.30	062092593
06953/A	Manicotto Carburatore Diam.20	032517758
06953/B	Manicotto Carburatore Diam.32	032517753
06958	Anello Elastico	59567
09973	Cuffia Contagiri/Km Ducati	079637045/2
10914	Vaschetta Batteria	
10914/A	Vaschetta Batteria	069838830/1
12921	Guarnizione 72 X 62 X 4,7	075949865
12922	Gommino Filtro Olio	075549275
12923	Boccola 18,5 X 14,5 X 16,5	079637770/1
12924	Cappuccio	060946060



★ 12921



06958



★ 12922



★ 12923



★ 12924



★ 10914/A



★ 10914



★ 06953
06953/A
06953/B



★ 06934/A



★ 06934



04983



★ 09973

<i>Articolo</i>	<i>Descrizione</i>	<i>Simile al Nr. Orig.</i>
03935	Cappuccio	12310005790
04909	Soffietтини Cavi	13104000130
05931	Cappuccio Cavo Carburatore	07004006180
06945/A	Pattino Guidacatena	5106314123
06974	Manicotto Marmitta	28313005370
06996/A	Rullo Tendicatena	46001005690
08910	Manicotto Carburatore Mikuni Da 26 - Fantic 50	16013005830
08911	Manicotto Carburatore 125 Trial	25048005100

GABBIANO

<i>Articolo</i>	<i>Descrizione</i>	<i>Simile al Nr. Orig.</i>
00592	Copripedale Guidatore Foro Cieco Diam. 14 - Lungh. 110 Marchio Gabbiano	

GARELLI

<i>Articolo</i>	<i>Descrizione</i>	<i>Simile al Nr. Orig.</i>
02807	Parastrappi Frizione Katia	003577153
02807/A	Parastrappi Frizione Katia - Tipo Grande -	
02807/B	Parastrappi Frizione Noi - Vip - 1 Velocita'	0023917153
02807/C	Parastrappi Frizione Kickstart 2 V.	2050107153
02885	Guarnizione Con Molla Per Volano 3b 2^ Serie	
04979	(E) Guarnizione Cilindrica Frizione Automatica	
06994	Bussola Antivibrante	0009121543
06995	Tampone Spingidisco	0243577829



03935



05931



04909



06974



08910
08911



06945/A



★ 06996/A

GABBIANO



★ 00592

GARELLI



★ 02885



★ 06994



★ 06995



★ 04979



★ 02807



★ 02807/A

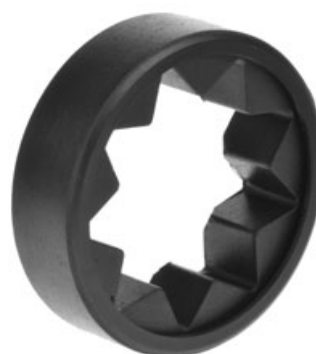

★ 02807/B

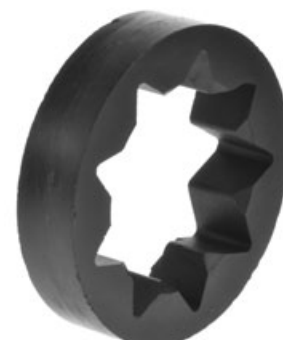

★ 02807/C

<i>Articolo</i>	<i>Descrizione</i>	<i>Simile al Nr. Orig.</i>
00506	Copripedale Guidatore 500 Cc. Foro Cieco 14	
00516	Coprileva Cambio VI - Foro Passante Diam.9 - Mod- 1936	
00610/11	Paio Manopole Gilera	
00610/11A	Paio Manopole Con Paramano (Marchio Sul Fondello) - B300 - 175 E	22370 - 22371
00610/11AR	Paio Manopole - Rosso	
00610/11GR	Paio Manopole Gilera G. 150	6271
00814	Parastrappi 125-150 Cc. 3 Marce Turismo Mm. 18 X 10 X 9	
00819	Parastrappi 150 Cc. 4 Marce Turismo E Sport Mm. 26x14x12	
00822	Parastrappi Ruota Posteriore 250 Cc.	
00843	Parastrappi Ruota Posteriore 300 Cc. Diam. 30x13x16 Mm.	
00848	Parastrappi Ruota Poster.175 Cc.Turismo Ø 25x15x13	
00849	Parastrappi Ruota Posteriore 175 Sport	27588
00907	Anello Parapolvere Mozzo Ruota 250 Cc.	
01534	Coprileva Freno 125-175 Cc.	
01546	Coprileva Cambio (Posteriore) Giubileo - Ovale - Foro Rettangolare Verticale 14x4 - Lungh.40 Giubileo tutte le Versioni 98/124/150/175 Cc. dal 1959 al 1968	22929
01546/A	Coprileva Cambio (Anteriore) Giubileo - Ovale - Foro Rettangolare Verticale 14x4 - Lungh.60 Giubileo tutte le Versioni 98/124/150/175 Cc. dal 1959 al 1968	22264
01547	Coprileva Avviamento Diam.14 Lungh.78 - Foro Cieco	
01830	Parastrappi Mozzi Grimeca Diam.116 4 Fori - Giubileo 98 - Extra 29921	21696
01851/A	Guarnizione Tappo Serbatoio Benzina Diam.61x40x4	
01869	Guarnizione Forcella 150 Cc. Diam.30,5x24x4	
02878	Guarnizione Astina Frizione 150 Cc.	



★ 00506



★ 00516



★ 01546/A



★ 01546



★ 01547



★ 0610/11
00610/11GR



★ 00610/11A
00610/11AR



★ 00814



★ 00819



★ 00822



★ 00843



★ 00848

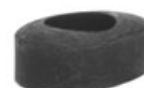

★ 00849



★ 01851/A



★ 01869



★ 00907



★ 02878



★ 01830



★ 01534

<i>Articolo</i>	<i>Descrizione</i>	<i>Simile al Nr. Orig.</i>
00405/06	Paio Ginocchiere 250-500 Cc. - 1947	9239/9240
00417/18	Paio Ginocchiere Dx-Sx Per 98 Ss - 124 5v Special	664089/64090
00504	Copripedale Guidatore Saturno-Nettuno Foro Pass.14 Mm.	6332
00505	Copripedale Guidatore Mod. VI Foro Passante 14	
00507	Coprileva Cambio Saturno 500 Parallelogrammo '46/52 - Nettuno 250 Turismo '47/52	
00538	Copripedale Guidatore 125-150-300 Cc. dal 1951 al 1964 - Foro Cieco Diam. 14 - Lungh.105	21367
00539	Coprileva Cambio 125-150 Turismo - Foro Cieco Diam.10 - Lungh.53	
00539/A	Coprileva Cambio 150 - 300 Sport Foro Rettangolare	22264
02946	Boccola Attacco Posteriore Serbatoio 175 Cc.	
02947	Boccola Attacco Serbatoio	26233
02948	Boccola Trascinamento Ventola Motocarro 150 Cc.	
03921	Boccola Attacco Anteriore Serbatoio Benzina 150 Cc. 2 Serie	
03988	Cinghia Fissaggio Batteria - Giubileo 98 - 124 Cc.	26550
04916	Tappo Ispezione Catena B/300 Cc.	
04925	Soff.Parapol.Paraf.Anteriore	
04954	Soffietto Aspirazione Carburatore Scooter	45349
04955	Manicotto Carburatore 175 Cc.	
05854	Guarnizione Ad Anello Per Tamburo Frizione 125 - 150 Cc.	
05919	Passafilo Astina Frizione 98-124-175 Cc.	29613
06911	Soffietto Aspirazione 50 Cc.	



03988



★ 00405/06



★ 00417/18



★ 00504



★ 00505



★ 00538



★ 00539



★ 00539/A



★ 00507



★ 04954



★ 02947



★ 02948



★ 05854



★ 03921



★ 02946



★ 04916



★ 05919



★ 06911



★ 04955



★ 04925

<i>Articolo</i>	<i>Descrizione</i>	<i>Simile al Nr. Orig.</i>
00574	Copripedale Guidatore Lungh. Mm.110 Foro Cieco Diam. 14 Mm.	
00635/36	Paio Manopole Diam.22-24	

GRIMECA

<i>Articolo</i>	<i>Descrizione</i>	<i>Simile al Nr. Orig.</i>
01803	Parastrappi Mozzi Grimeca Diam.145	1730
01807	Parastrappi Mozzi Grimeca	621102452
01823	Parastrappi A Stella Mozzi Grimeca Diam.83	621306582
01824	Parastrappi Mozzi Grimeca Diam.83 4 Fori	621201936
01825	Parastrappi Mozzi Grimeca Diam.88 4 Fori Tipo Mb	621200202
01826	Parastrappi A Stella Mozzi Grimeca Diam.108	621300130
01827	Parastrappi Mozzi Grimeca Diam.108 4 Fori	62120174
01831	Parastrappi A Stella Diam. 108 Mm.	
01833	Parastrappi Mozzi Grimeca Diam.127 4 Fori	621200173
01843	Parastrappi A Stella Mozzi Grimeca Diam.179 Spessore 20 Mm.	
01843/A	Parastrappi A Stella Mozzi Grimeca Diam.179 Spessore 14 Mm.	621306595



☆ 00635/36



☆ 00574

GRIMECA



☆ 01803



☆ 01843
01843/A



☆ 01823



☆ 01826



☆ 01827



☆ 01807



☆ 01833



☆ 01824



☆ 01831



☆ 01825

<i>Articolo</i>	<i>Descrizione</i>	<i>Simile al Nr. Orig.</i>
00102	Paraolio Aste Valvole Galletto	
00401/02	Paio Ginocchiere Super Alce	
00415/16	Paio Ginocchiere Per Bauletto Galletto	
00503	Copripedale Passeggero Foro Diam.18 Lungh.107	
00513	Coprileva Cambio	
00514	Paio Copripedali Guidatore Sport 15 Bordo Ovale	
00515	Copripedale Guidatore	
00546	Copripedale Guidatore	
00546/A	Copripedale Guidatore Zigolo	
00554	Copripedale Passeggero	
00567	Coprileva Cambio Melior Doppio	
00568	Coprileva Cambio Melior Semplice	
00586	Copripedale Guidatore Cardellino 65 Cc. Foro Rettangolare	
01523	Copripedale Guidatore Cardellino - Lodola	55443200
01568	Copripedale Guidatore Dingo-Stornello Diam.13	40443200
01573	Copripedale Passeggero Stornello - V7	55443385
02510	Coprileva Cambio V 50 - 850 - 1000	14251001
02511	Copripedale V50 - 850 - 1000	14443200
02524	Copripedale Guidatore 850 T5 Lario	28443201
02525	Copripedale Passeggero 850 T5 Lario	28443300
05962	Passacavo Ad Occhiello	13436561
05989/A	Tampone Ancoraggio Serbatoio	39103400



05962



05989/A



★ 00401/02



★ 00415/16



★ 00503



01568



01573



★ 00515



★ 00514



★ 00546/A



★ 00546



00554



★ 00567



★ 00568



★ 00513



★ 00586



01523



★ 00102



02510



02511



02524



02525

<i>Articolo</i>	<i>Descrizione</i>	<i>Simile al Nr. Orig.</i>
00513/A	Coprileva Freno Zigolo	
00526	Coprileva Freno Standard Foro Rettangolare 32 X 6	
00556	Coprileva Selettore Cambio Galletto E 250 Cc - Foro Tondo	
00557	Coprileva Avviamento Galletto - Foro Passante Diam. 13 Mm	
00601/02	Paio Manopole - Foro Passante Mm.24-Foro Cieco Mm.21	
00602	Paio Manopole Guzzi Foro Cieco Mm.21	
00602/661	Paio Manopole Lodola 175 Cc. Sport Diam.21/24	
00603	Paio Manopole Foro Passante Mm.27	
00603/05	Paio Manopole Foro Passante Mm.27-24	
00604	Paio Manopole Foro Cieco Mm.24	
00604/03	Paio Manopole Foro Cieco Mm.24 - Foro Passante Mm.27	
00604/05	Paio Manopole Foro Cieco Mm.24 - Foro Passante Mm.24	
00605	Paio Manopole Foro Passante Mm.24	
00613	Paio Manopole Manubrio Posteriore Superalce	
00677	Paio Manopole Cardellino - Zigolo - Stornello - Lodola	
00677/A	Paio Manopole Galletto	
00695	Paio Manopole Diam.22-24 In Neoprene	14603000/3500
00802	Parastrappi Sport/15	08336800
00803	Premistoppa Dinamo 250-500 Cc. - Mm.34,5 X 22 X 10	
00807	Parastrappi Galletto 160-175-192 - Airone 250 1947/1948 - Airone Sport 1949/1952 - Zigolo 98	T-2206
00809	Parastrappi Alce	
00815	Paracolpi Sospensione Anteriore Galletto Diam.24 X 10 X 9	
00815/A	Paracolpi Sospensione Anteriore Galletto Diam. 27,5 X 9 X 9	
00815/B	Paracolpi Asta Forcella Galletto 192/59-62 Diam. 24x12x9	
00816	Anello Fine Corsa Sospensione Anteriore Galletto 37x14x15	
00826	Paracolpo Arresto M/Moto Zigolo Gambo Diam.12	
00826/A	Paracolpo Arresto M/Moto Zigolo Gambo Diam.7	
00835	Boccola Attacco Ammortizzatore Anteriore Galletto	
00835/A	Boccola Perni Biscottini Asta Galletto	93110129
01535	Coprileva Cambio Lungh. 46 Foro Passante Diam. 10 - Lodola 175 Cc - V7 - Nuovo Falcone 1972	
01591	Copripedale Guidatore Lungh. 94 Foro Cieco A Sezione Ovale	
01842	Parastrappi Frizione Trotter	
07976	Manicotto Carburatore-Filtro Stornello	54114301



00556



00557



01535



★ 00513/A



★ 00601/02
00602
00602/661



★ 00603
00603/05
00604



★ 00605
00604/03
00604/05



★ 00613

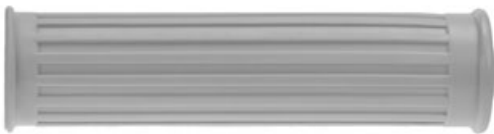

★ 00677
00677/A



00695



★ 00802



★ 00809



★ 00803



★ 00807



★ 00815/A



★ 00815
00815/B



★ 00816



★ 00826/A



★ 00826



★ 00835
00835/A



★ 01842



★ 01591



★ 07976



★ 00526

<i>Articolo</i>	<i>Descrizione</i>	<i>Simile al Nr. Orig.</i>
00804	Parastrappi 500 Cc	
00842	Parastrappi Lodola 175 Cc.	93110200
00851	Premistoppa Dinamo Ercole - Astore - Alce	
00851/A	Premistoppa Dinamo Ercole-Astore-Falcone (35x25x5)	
00853	Premistoppa Aste Valvole Astore - Alce	
00853/A	Premistoppa A Soffietto Aste Valvole 500 Cc.	
00853/AS	Premistoppa A Soffietto Aste Valvole In Silicone	
00858/A	Premistoppa A Soffietto Aste Valvole Airone 250 Cc.	
00858/AS	Premistoppa A Soffietto Aste Valvole Airone 250 Cc. Silicone	
00868/A	Premistoppa Dinamo Airone	
00899	Guarn. Ammort. Post. 250-500 Cc. Diam. 20x11x3,5 Mm	
00905	Soffietto Sospensione Anteriore 250 Cc.	
02509	Tappeto Pedana V7 California	13447040
02855	Anello Paraolio Forcella Anteriore 250-500 Cc.20,5x12,5x3,5	
03855	Guarnizione Tappo Testa 250-500 Cc. Diam.39x32x2	
04871	Cilindretto Elastico Per Coppia Trasmissione Cardellino 73cc	
04893	Cilindretto In Gomma Per Ingranaggio Distribuzione Lodola	
04894	Cilindretto Gomma Per Pignone Conico Albero Motore Lodola	
04913	Soffietto Uscita Cavi	17755300
06852	Guarniz. Nella Bronzina Preselettore Lodola 175 Cc. Sport	
06853	Guarnizione Nella Testa Per Asta Tendicatena Lodola	
06870	Paraolio Aste Valvole Stornello	
06870/A	Paraolio Aste Valvole Stornello Sport	
06870/AS	Paraolio Aste Valvole Stornello Sport - Silicone -	
06871	Guarnizione Tirante Cilindro Stornello Foro Mm.7,5	
06871/S	Guarnizione Tirante Cilindro Stornello - Silicone -	
06872	Guarnizione Tirante Cilindro Stornello Foro Mm.10	
06872/S	Guarnizione Tirante Cilindro Stornello - Silicone -	
06873	Guarnizione Fine Corsa Forcella Lodola - Diam. 41x29x5,5 Mm.	
07942	Tappo Chiusura Fori Portabagaglio	93180060
07954	Bussola Fissaggio Contagiri 1000 GS	91551165
10850	Guarnizione Per Tubo Copri Astine Nuovo Falcone 500 Cc.	10022800
10931	Cappuccio Connettore Maschio a 4 Vie	17756060
12926	Collettore Carburatore Filtro V7 Ii Serie	12114301
12927	Collettore Carburatore Filtro V7 I Serie 700 Cc	12114300



<i>Articolo</i>	<i>Descrizione</i>	<i>Simile al Nr. Orig.</i>
00900	Guarnizione Ammortizz. Post. 250-500 Cc. Diam. 28x22x3 Mm	
00923/A	Cappuccio A Pipa	
01903	Guarnizione Tappo Serbatoio Benzina Guzzino 65 Cc. 47x37x2,5	
01904	Guarnizione Tappo Serbatoio Benzina Diam. 44x37x3 Mm.	
02902	Blocchetto Forcellone Oscillante Cardellino 65-73 Cc	
02902/A	Blocchetto Forcellone Super Alce	
02911	Tappo Protezione Arresto Manubrio Galletto 192 Cc.	
02929	Boccola Fissaggio Serbatoio Lodola 175 Cc./V7 700 Cc.	55103425
02934	Passacavo Sul Cruscotto Galletto	
02936	Guarnizione Per Filtro Carburatore Galletto 175 Cc.	
02937	Guarnizione Filtro Carburatore Galletto 192 Cc.	
02938	Guarnizione Tappo Serbatoio Tebaldi Diam. 55x30x5	
02999	Rullino Per Forcella Lodola Diam.25x8x18	
02971	Boccola Ammortizzatore Mm 12 X 25 X 11 - Stornello	13619633
03902	Boccola Ammortizzatore Mm 26 X 15 X 13	18551650
04922	Passacavo Per Guscio Di Protezione Zigolo 110 Cc.	
05904	Boccola Attacco Motore Trotter	
05909	Tampone Arresto Leva Messa In Moto	
05947	Guarnizione Tappo Serbatoio Benzina Stornello	
05950	Boccola Attacco Anteriore Serbatoio Dingo	
05959	Calotta Forcella Diam.30 Per Scrambler	
05960	Calotta Forcella Diam 33	14524500
06910	Tappo Ispezione Ingranaggi V 7	93180220
06937/A	Manicotto Carburatore V50/Iii Monza	19114380
06952	Manicotto Carburatore Diam.25	61114300
06952/A	Manicotto Carburatore V35-50 Imola Diam.27	62114300
06952/C	Manicotto Carburatore Bc 750 Diam.27	63114300
06955	Manicotto Carburatore Diam.30	
06955/A	Manicotto Carburatore Diam.34	
06955/B	Manicotto Carburatore Diam.36	14114350
06955/C	Manicotto Carburatore Diam.40	28114340
07934	Cappuccio Commutatore A Chiave V7 S5-Le Mans	14735800
07938	Cappuccio Pompa Freno A Disco 250 Ts	39663801
07939	Anello Inferiore Parapolvere Cuscinetti V7	14517000
07945	Tampone Appoggio Serbatoio Sella E Trousse V7 S5	14103800
07946	Calotta Di Fermo Sul Puntale V7 S5	14423800
07949	Bussola Conica Tenuta Olio Asta Frizione V7 Sport-Le Mans	14085900
07955	Tampone Laterale Appoggio Serbatoio V7 S5	14109000



☆ 00900



☆ 01904



☆ 01903



07939



☆ 02936



☆ 02929



☆ 02934



☆ 02971



☆ 07945



02999



☆ 03902



☆ 02938



☆ 02937



07955



00923/A



07938



☆ 05909



☆ 05947



☆ 05950



☆ 02911



☆ 06910



☆ 05904



☆ 07946



☆ 04922



☆ 07949



06952
06952/A



06952/C



06937/A



06955
06955/A
06955/B
06955/C



☆ 02902



☆ 05959



05960



☆ 07934



☆ 02902/A

<i>Articolo</i>	<i>Descrizione</i>	<i>Simile al Nr. Orig.</i>
01807	Parastrappi Mozzo Campagnolo-Grimeca Per Zigolo - Stornello	24336800
04911	Soffietto Protezione Cavo Freno Anteriore V7 Sport	12626300
04974	Soffietto Forcella Stornello 120-160 Cc - Dingo Cros - Super - Gt	
05922/V	Or In Viton	
06964	Tampone Borsette 125 - 250 2c	
07933	Copriregistro Trasmissione V 850 T3	17093850
07957/A	Cappuccio Interruttore Stop Diam.19 . Cavo Diam. 6	
07958	Pipetta Recupero Olio 850 T3	17154950
07959	Pipetta Sfiato Olio 850 T3	17154850
07960	Collettore Aspirazione 850 T3	17114350
07962	Custodia Contagiri/Km V7 S5	14762001
07963	Vaschetta Batteria	14707000
07967	Protezione Cavo Comando Freno Anteriore V7 S5	14626300
07973	Collettore Aspirazione	14114300
07991	Soffietto Giunto Cardanico V7	12548000
07992	Soffietto Giunto Cardanico V7 Convert	18548000
08929	Soffietto Giunto Cardanico V35-V50	19548001
10880	Serie Parastrappi Ruota Posteriore V 35 (Confezione Da 12 Pezzi)	19632501/02
10883	Serie Parastrappi Ruota V7-Sport '74 - 850T/T3 (Confezione Da 12 Pezzi)	14336803



07933



☆ 01807



05922/V



☆ 06964



07957/A



☆ 07967



10883



07959



07958



07962



04974



☆ 04911



08929



10880



07992



07991



07973



07960



07963

<i>Articolo</i>	<i>Descrizione</i>	<i>Simile al Nr. Orig.</i>
00692/A	Paio Manopole 22-24 Modelli Anni 70-80	
01582	Coprileva Cambio Lungh. 39 Foro Passante Diam.7	
01589	Coprileva Avviamento Lungh.73 Foro Passante Diam.11	
01612	Paio Manopole In Gomma Lungh. 130 Mm	
01612/A	Paio Manopole In Pvc Lungh. 130 Mm	
01612/SS	Paio Manopole In Supersoft Lungh. 130 Mm	
01614/A	Paio Manopole 22-24 Off Road	
01661/SSF	Paio Manopole In Supersoft - Fondello Forato - Lungh.120 Mm	
01682/SSF	Paio Manopole In Supersoft - Fondello Forato - Lungh.125 Mm	
01686/SSF	Paio Manopole In Supersoft - Fondello Forato - Lungh.120 Mm	
02522	Coprileva Cambio	24781419000
02523	Coprileva Cambio	24781449000
02534	Pedana Guidatore + Pass. Honda Nsr 125 / Revere 600 Guidat.	50661MJ4670
09981	Paio Soffietti Colore Nero - Transalp 600	
10942	Silentblock Marmitta	18355-KS6-000
10953	Paio Soffietti Forcella Scooter Honda Sh 50-80 Scoopy	
12993	Tampone Fermo Cavalletto Honda Sh - Cbr 600 Rr3	50505-GR1-000





01582



01589



12993



01612
01612/SS
01612/A

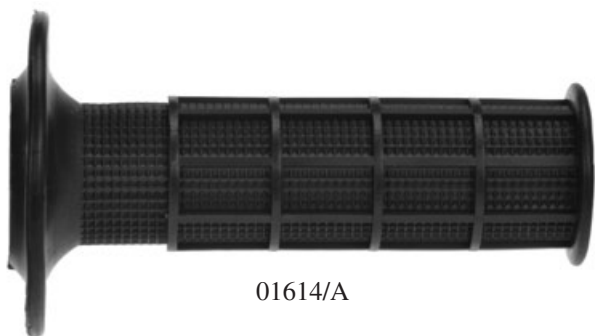

01614/A



01661/SSF



01682/SSF



01686/SSF



02522



02523



02534



10942



09981



10953

<i>Articolo</i>	<i>Descrizione</i>	<i>Simile al Nr. Orig.</i>
00508/A	Copripedale Guidatore Isomoto Diam. 14	
00508/C	Copripedale Guidatore Diam.14	
00512	Coprileva Cambio Isomoto Foro Diam.10	
00583	Coprileva Cambio Isoscooter 125 Cc.	
00584	Coprileva Freno Isoscooter 125 Cc.	
00585	Coprileva Avviamento Isoscooter 125 Cc.	
00589	Paio Staffe Per Passeggero	
01540	Coprileva Avviamento Isoscooter 150 Cc.	
01541	Coprileva Freno Isoscooter 150 Cc.	
01550	Scarpetta Cavalletto Isoscooter 150 Cc.	
01928	Tampone Arresto Forcella Posteriore E Leva Avviamento	
01970	Soffietto Sospensione Anteriore	
01971	Tappo Per Forcella	
01975	Guarnizione Supporto Portapacchi	
03991	Soffietto Aspirazione Scooter 150 Cc.	



★ 00508/C



★ 00585



★ 00512



★ 01971



★ 00584



★ 01541



★ 01540



★ 01975



★ 00589



★ 01550



★ 01928



★ 00508/A



★ 03991



★ 01970



★ 00583

<i>Articolo</i>	<i>Descrizione</i>	<i>Simile al Nr. Orig.</i>
01585	Coprileva Cambio Lungh.44 Foro Passante Diam.9	
01679/SSF	Paio Manopole In Supersoft Lungh. 120 Mm - Forate	
01685/SSF	Paio Manopole In Supersoft Lungh. 120 Mm - Forate	
02625/SSF	Paio Manopole In Supersoft Lungh. 120 Mm - Forate	

KREIDLER

<i>Articolo</i>	<i>Descrizione</i>	<i>Simile al Nr. Orig.</i>
00697	Paio Manopole Ciclomotore	
01584	Coprileva Avviamento	156062
01609/A	Paio Manopole 22-24 Comando Magura	
01611	Paio Manopole 22-24 Comando Magura	
02514	Coprileva Cambio	155016
02515	Appoggiapiede Guidatore Diam. Int. 16 Mm	
02515/A	Appoggiapiede Guidatore Diam. Int. 18 Mm	51310004
02801	Parastrappi Ruota Posteriore	061577
02805	Parastrappi Singolo Ruota Posteriore	
06990	Soffietto Forcella	570613
07982	Tappo Carter Catena	
08940	Tappo Carter Catena	150210
08941	Boccola	030402
08967	Soffiettino Cavi	2151306



01679/SSF



01585



01685/SSF



02625/SSF

KREIDLER



★ 00697



01609/A



★ 01611



★ 02515
02515/A



02514



01584



★ 02805



★ 07982



★ 08940



★ 08941



★ 02801



08967



★ 06990

<i>Articolo</i>	<i>Descrizione</i>	<i>Simile al Nr. Orig.</i>
00525	Coprileva Freno Lambretta C	3T714
00530	Coprileva Avviamento Mod.B E Mod.C	3M436
00552	Copripedale Motocarro 1^ Serie	
00618	Paio Manopole Lambretta B - Colore Grigio	3ST413
00625	Paio Manopole Lambretta C E D - Foro Passante Diam.26	6ST410
00625/A	Paio Manopole Con Paramano Mod C E D - Foro Diam.26	
00648	Paio Manopole Lambretta D-Ld 1953 Diam.25	96206
00649	Paio Manopole Lambretta D-Ld 1953 Diam.27	
00656	Paio Manopole Con Paramani D/150-Ld-F Diam. 27 Mm.	7770403
00660	Paio Manopole Ciclomotore Lambretta Diam.24-24	14060206
00668	Paio Manopole Bombate Diam.24 Grigio	
00668/A	Paio Manopole Bombate Diam.21 Grigio	
00670	Paio Manopole Li Nero	19062616
00670/B	Paio Manopole Lambretta J-50 Diam. 14	30011001
00670/B-GR	Paio Manopole Lambretta Junior Diam.14 Grigio	20011001
00670-GR	Paio Manopole Li Grigio	19062616
00679	Paio Manopole Li 3^ Serie 24/24 Nero	22062016
00679-GR	Paio Manopole Li 3^ Serie 24/24 Grigio	19962016
00864	Paracolpi Fiancate Con Vite Incorporata Mod. Ld	121910061
00884	Guarnizione Tappo Serbatoio Benzina Mm. 42 X 32 X 2	99097007
00913/A	Cappuccio Presa Bassa Tensione 150 Cc.	99098221
01548	Coprileva Freno Li 150 Cc.	220059003
01548-GR	Coprileva Freno Li 150	15059003
02859	Guarnizione Tenuta Perno Ruota 150 Cc.	2160137



★ 00648
★ 00649

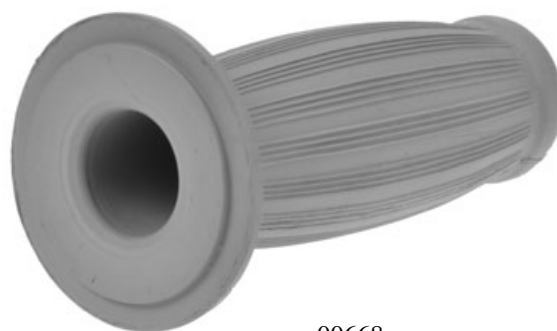

★ 00668
★ 00668/A

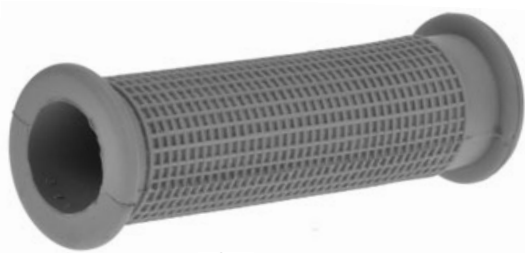

★ 00618



★ 00625/A



★ 00913/A



★ 00625



★ 00656



★ 02859



★ 00884



★ 00660



★ 00552



★ 00530



★ 00670/B

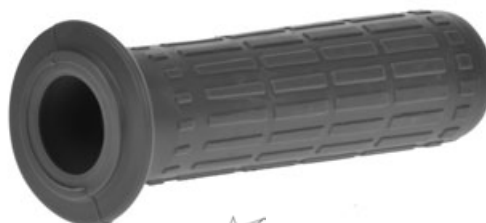

★ 00670/B-GR



★ 01548/GR



00670

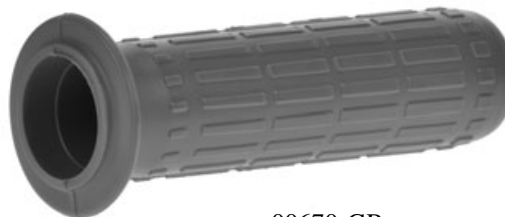

00670-GR



★ 01548



★ 00525



00679



★ 00679-GR



★ 00864

<i>Articolo</i>	<i>Descrizione</i>	<i>Simile al Nr. Orig.</i>
00919	Guarnizione Per Vetro Faro Anteriore Diam. 85 Mm.	
00919/A	Guarnizione Per Vetro Faro Anteriore Diam. 70 Mm.	
00920	Guarnizione Per Vetro Faro Anteriore Diam. 95 Mm.	99098006
00920/A	Guarnizione Vetro Faro Anteriore Diam. 130 Mm.	
00924	Pipetta Capocorda Candela	2A501
00940	Cappuccio Protezione Molleggio Anteriore Mod. C-Lc	6ST121
00947	Collare Di Guarnizione Per Tappo Serbatoio Benzina	25115
00947-GR	Collare Di Guarnizione Per Tappo Serbatoio Benzina -Grigio-	25115
00955	Tappo Grigio Portello Ispezione Mod. Lc-Ld	5T240
00956	Cappuccio Gancio Scudo Mod. Lc-Ld	5T235
00958	Boccola Per Guaina Uscita Fili	06770214
00959	Tampone Sospensione Posteriore	6TR515
00968/69	Paio Tappetini Grigio Tutta Gomma Dx-Sx Mod.Lc	8181241
01905	Anello Di Guarnizione Diam. 22 Mm. Corda 1,8	19030032
01906	Tamponcino Parafango Anteriore Mod.D	7180302
01908	Tampone In Gomma Fine Corsa Molleggio Anteriore D-Ld	99106052
01908/A	Tampone Gomma Fine Corsa Molleggio Posteriore D-Ld	40770113
01909	Tampone Parafango Anteriore Mod.D	15060039
01915	Tampone Di Fine Corsa Molleggio Posteriore D-Ld 150 Cc.	71800616
01918/A	Tampone In Gomma Per Molleggio Motore D-Ld	7111016
01919	Coprileva Avviamento Mod. D 125 Cc.	7110437
01919/A	Copripedale Avviamento Tipo E - Ld/1953	7110637
01946	Maniglia M/Moto Lambretta E Colore Grigio	91309
01946-N	Maniglia M/Moto Lambretta E Colore Nero	
01948	Tampone Fine Corsa Molleggio Mod. E-F	95032
01949	Anello Per Astina Frizione Diam. 7 X 7 Mm.	92015
01952	Paracolpo Ad U Per Sterzo	96022
01954	Coprifreno Lambretta D-Ld 150 Grigio	99095906
01955	Protezione Guaina Grigio Comando Cambio	
01957	Protezione Guaina Grigio Comando Gas	
01984	Cappuccio Porta Guaina Gas Al Carburatore Mod. D	412053



☆ 00920/A



☆ 00920



☆ 00956



☆ 00924



☆ 00940



☆ 01909



☆ 00947-GR



☆ 00947



☆ 00955



☆ 00958



☆ 01905



☆ 01906



☆ 01908/A



☆ 01908



☆ 01948



☆ 00968/69



☆ 01915



☆ 00959



☆ 00919



☆ 00919/A



☆ 01952



☆ 01919



☆ 01919/A



☆ 01946-N



☆ 01946



☆ 01954



☆ 01918/A



☆ 01949



☆ 01955



☆ 01957



☆ 01984

<i>Articolo</i>	<i>Descrizione</i>	<i>Simile al Nr. Orig.</i>
02903-K	Profilo Grigio Per Pedana Ld - A Peso	8180140
02903-K-N	Profilo Nero Per Pedana Ld - A Peso	8180140
02907	Coprileva Avviamento Mod.D 150 Cc.	11110437
02912	Cappuccio Gomma Antiolio Gancio Carenatura Ld 150 Cc.	15055046
02915	Coprileva Avviamento 150 Cc. 1955	12110438
02915/A	Coprileva Avviamento Mod. Ld 1957 Prima Serie	12110436
02915/B	Coprileva Avviamento Mod. Ld 1957 Seconda Serie	12110426
02915/C	Coprileva Avviamento Mod. Li 1° Serie	15041033
02915/D	Coprileva Avviamento Li 2^ Serie	19030037
02915/E	Coprileva Avviamento Li 3^ Serie	19030042
02915/E-GR	Coprileva Avviamento Li 3^ Serie - Grigio -	19030042
02915/F	Protezione Leva Avviamento Fli-Lambro 200	
02915/G	Coprileva Leva Avviamento 100-125 Junior	2054011
02939	Soffietto Parapolvere Per Albero Trasmissione Fd 150 Cc.	18331107
03907	Scarpetta Per Cavalletto Li 1/2/3^ Serie - Tv	15057020
03907/A	Scarpetta Per Cavalletto Junior	20032020
03907-GR	Scarpetta Cavalletto - Grigio - Li 2a-3a Serie - Tv	15057020
03915	Tampone Fermo Cavalletto	15057007
03916	Tubo Collegamento Carburatore 48 Cc.	14010604
03928	Distanziale Per Fiancata	15050065
03934	Guarnizione Tappo Serbatoio Li Diam. 42 X 27,5 X 3 Mm.	15070021
03951	Tampone Per Bauletto	15086009
03953	Tampone Per Parafango Posteriore	1505057



★ 02903-K
★ 02903-K-N



★ 03915



★ 03953



★ 02912



★ 02915/A



★ 02915/B



★ 02915/C



★ 02915/D



★ 02915/E-GR



★ 02915/E



★ 02915/F



★ 02915



★ 02907



★ 02915/G



★ 03907/A



★ 03907



★ 03907-GR



★ 03916



★ 02939



★ 03928



★ 03934



★ 03951

<i>Articolo</i>	<i>Descrizione</i>	<i>Simile al Nr. Orig.</i>
00972	Tappo Per Fori Supporto Ruota Di Scorta	
00972/A	Tappo Con Gambo Lungo Per Fori Supporto Ruota Di Scorta	
00972/A-GR	Tappo Con Gambo Lungo Per Fori Supporto Ruota Di Scorta - Grigio	
00972-GR	Tappo Per Fori Supporto Ruota Di Scorta - Grigio	
03914	Soffietto Cuffia Carburatore Ld 125-150 Cc.	12110716
03917/A	Paio Profili Per Scudo Li 3 [^] Serie - Nero	22050062
03917/A-GR	Paio Profili Per Scudo Li 3a Serie - Grigio	19950073
03917/A-K	Profilo Per Scudo Li 3a Serie - Nero - al Kg.	
03917/AKGR	Profilo Per Scudo Li 3a Serie - Grigio - al Kg.	
03936	Paio Spezzoni Profilo Fiancata Li 150 Cc. Nero	15055059
03936-K	Profilo Fiancata al Kg. Nero	15055059
03936-GR	Paio Spezzoni Profilo Fiancata Li 150 Cc. Grigio	15050046
03936-KGR	Profilo Fiancata Al Kg. Grigio	19022015
03954	Tampone Supporto Sostegno Serbatoio	15050021
03959	Membrana Presa Aria Carburatore Mod. Tv 175 Cc.	412213
03960	Tampone Di Fine Corsa Li 150 Cc.	19010036
03961	Passacavo Rubinetto Benzina Li	
03983	Soffietto Aspirazione Carburatore Li 2 [^] Serie	19016021
03983/A	Soffietto Aspirazione Carburatore Li 3 [^] Serie	19916022
03983/B	Soffietto Aspirazione Carburatore Junior	20055004
04909	Soffietto Protezione Cavi Li	
04949	Protezione Comando Freno Posteriore Li 150/175 Cc. - Tv	
04969	Tampone Serbatoio	
04981	Parapolvere Ceppi Freno Lambro	
05868	Anello Tenuta Mozzo Anteriore Li Diam. 58x47x5	
05869	Guarnizione Ad Anello Per Albero Secondario Cambio Li	
05870	Guarnizione Ad Anello Per Albero Leva Comando Cambio Tv	
05871	Anello Or Per Comando Frizione E Cambio Li (= 00330)	
05873	Guarnizione Ad Anello Per Canna Ruota Posteriore Li	
05907	Scarpetta Cavalletto Lui	
09986	Griglia Freno Bianca	19744068
10904	Tampone Molleggio Anteriore	15060100
10907	Tampone Molleggio Anteriore Grande	15060070



☆ 03954



☆ 03960



03961



04969



03936
☆ 03936-K
03936-GR
03936-KGR



☆ 04981



☆ 05868



☆ 05869



☆ 05870



☆ 05871



☆ 05873



☆ 10904



☆ 10907



04949



☆ 09986



☆ 05907



☆ 03917/A
03917/A-K ☆ 03917/A-GR
03917/AKGR



☆ 00972/A-GR



☆ 00972/A



☆ 00972



☆ 00972-GR



03914

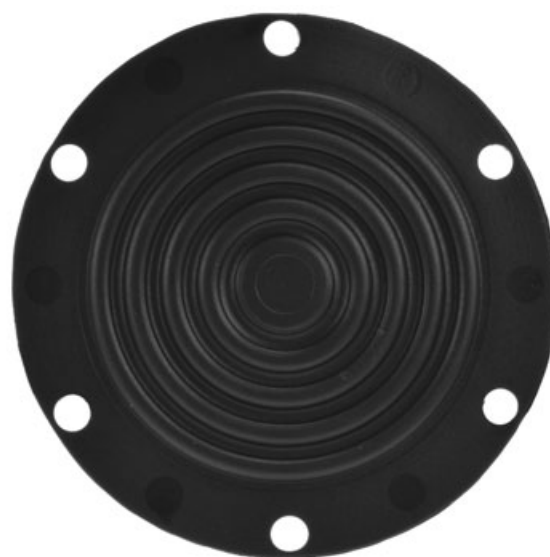

☆ 03959



☆ 03983/B



☆ 03983/A



04909



☆ 03983

<i>Articolo</i>	<i>Descrizione</i>	<i>Simile al Nr. Orig.</i>
00518	Appoggiapiede Passeggero Tipo B	
03949	Paio Profili Lambretta Grigio	15059022
04910	Soffietto Protezione Cavi Fli	
04911	Protezione A Soffietto Cavi Comando Cambio Fli	
04984	Soffietto Aspirazione DI 150/200	
04985	Soffietto Aspirazione DI 125	
09984	Guarnizione Scatola Filtro Lambretta Dal 1961 (Tutti I Tipi)	
09987	Profilo Bauletto Nero Li 1-2-3 [^] Serie - Sx - Tv - Gp	
10946	Profilo Nero Raccordo Pedana Li/Tv Lungh. Cm 45	
10946-GR	Profilo Grigio Raccordo Pedana Li/Tv Lungh. 45 Cm	
10951	Paio Profili Neri Scudo/Frontale Lambretta Gp - DI	19950046



☆ 00518



☆ 04910



☆ 09984



☆ 09987



☆ 04985



☆ 04984



☆ 04911



☆ 03949



☆ 10951



☆ 10946-GR



☆ 10946

<i>Articolo</i>	<i>Descrizione</i>	<i>Simile al Nr. Orig.</i>
03992	Soffietto Aspirazione Carburatore Fli 175 Cc.	
04970	Manicotto Aspirazione Lambro 450-500 2^ Tipo	
04970/A	Manicotto Aspirazione Lambro 450-500	
04970/B	Manicotto Aspirazione Lambro 550/V 1^ Tipo	
04970/C	Manicotto Aspirazione Lambro 550/V 2^ Tipo	

LAVERDA

<i>Articolo</i>	<i>Descrizione</i>	<i>Simile al Nr. Orig.</i>
00558	Copripedale Guidatore e Passeggero 200 Cc. Bicilindrico	358/B
00558/A	Copripedale Guidatore Con Marchio In Rilievo	403
00582	Coprileva Selettore Foro Piatto Passante	
00658	Paio Manopole con Marchio 100 Cc. - Diam. 22-24 - La Destra ha Bordo Paramano	538/539
00676	Paio Manopole Per Scooter	326/A
01521	Coprileva Selettore Cambio 100 Cc.	253/CL1
01522	Coprileva Freno 100 Cc.	527/CL1
01549	Scarpetta Cavalletto Scooter	220/A
01559	Coprileva Freno 200 Cc. Bicilindrico	
01560	Copripedale Passeggero Scooter	221/A



☆ 03992



☆ 04970/A



☆ 04970/B



☆ 04970/C



☆ 04970

LAVERDA



☆ 00558/A



☆ 00558



☆ 01560



☆ 00582



☆ 01521



☆ 01522



☆ 01559



☆ 01549



☆ 00658



☆ 00676

<i>Articolo</i>	<i>Descrizione</i>	<i>Simile al Nr. Orig.</i>
00692/A	Paio Manopole 750 - 1000 Cc fino Agli Anni 90	60403991/60404992
00839	Parastrappi Ruota Posteriore 75/100cc.-16,5x8x13,5	468
00839/A	Parastrappi Ruota Posteriore 100 Cc.1958-16,5x9x14	
01561	Coprileva Selettore Cambio 200 Cc. Bicilindrico	245/B
01578/C	Appoggiapiede Guidatore Diam. 12 Mm (500 Cc)	50404056
01580	Appoggiapiede Guidatore 650 - 750 Cc Fino Al 1971 - Lungh. 115 Mm	214E
01580/A	Appoggiapiede Guidatore 750 Gt -Sf - Sfc - 1000 Cc dal 1972 - Lungh. 105 Mm	50404016
02971	Boccola Conica Ammortizzatore 100 Cc	
03938	Boccola Per Ammortizzatore Posteriore 100 Cc.- 1958-59	
03988	Elastico Batteria Dalla 650 Alla 1000 Cc	50403004
04931	Gommino Per Appoggio Serbatoio 200 Cc. Bicilindrico	449/B
04932	Supporto Marmitta 200 Cc. Bicilindrico	358/B
04933	Protezione Uscita Fili Volano Magnete 200 Cc. Bicilindrico	326/B
04934	Tappo In Gomma Per Appoggio Serbatoio 200 Cc. Bicilindrico	303/B1
04935	Paracolpi Fine Corsa Forcella Telescopica 200 Bicilindrico	429/B
04936	Paracolpi Fine Corsa Leva Avviamento 200 Cc. Bicilindrico	232/B
04938	Protezione Uscita Fili Volano Magnete Scooter	260/B
05933	Soffietto Cavi Comandi	58200191
05949	Elastico Per Fissaggio Posteriore Serbatoio 750 Sport E Batteria 250 Cc	50403011
05989/B	Tampone Ancoraggio Serbatoio	50402007
05993	Supporto Marmitta	50402009
05995	Paracolpi	50402060
06997	Paraspruzzi Tappo Serbatoio Benzina	36210250
07977	Soffietto Protezione	61928085
07978	Anello Antivibrante	50402008
07979	Appoggio Serbatoio	50401006
07981	Cappuccio Idrostop 750 Sfc	58200105
07982	Tappo Foro Ispezione Frizione 750 Gt/Sf- 1000 Tutti I Modelli	58000102
07983	Tampone Supporto Serbatoio 1000 Sc - 1000 RI	50401070
07989	Elastico Trousse 250 2t - 250 2tr	50403119
10887	Serie Parastrappi (8 Pezzi) Corona Catena 750 Sfc - 1000 Cc	50405023





01578/C



★ 01580/A



★ 01580



★ 07977



★ 07978



★ 04934



★ 04935



★ 04936



★ 05995



★ 04932



★ 05989/B



★ 05993



★ 07981



★ 07983



★ 05933



★ 06997



★ 07979



★ 10887



★ 01561



★ 04931



★ 04933



★ 04938



★ 03938



★ 00839



★ 00839/A



★ 07989



★ 07982



★ 02971



05949



03988

<i>Articolo</i>	<i>Descrizione</i>	<i>Simile al Nr. Orig.</i>
04937	Soffietto Aspirazione Carburatore Scooter	252/A
04975/A	Calotta Forcella Arces-Ceriani Diam. 32 Mm	
04991	Calotta Forcella Arces-Ceriani Diam 35 Mm	
06903	Calotta Forcella Arces-Ceriani Diam. 35 Mm	
06904	Calotta Forcella Arces-Ceriani Diam. 38 Mm	
07985	Soffietto Carburatore Filtro 1000 Tutti I Modelli - 750 Sf Lato Sinistro	36210111
07986	Soffietto Carburatore Filtro 1000 Tutti I Modelli - 750 Sf Lato Destro	36210112

MAICO

<i>Articolo</i>	<i>Descrizione</i>	<i>Simile al Nr. Orig.</i>
01507	Coprileva Diam. 12 Mm	1056600705
04999	Cappuccio In Silicone	
05962/A	Passacavo Ad Occhiello	149.08.005.0.9
06902	Tendifilo Gas Comando Magura	
06936	Manicotto Carburatore Bing 41 Mm	
06996/B	Rullino Tendicatena	336.06.052.0.4
08968	Paio Calotte Forcella Maico Diam. 41,7 - Mod. Dal 1981	6441
08968/A	Paio Calotte Raschiapolvere Forcella 38 Mm Fino Al 1980	79390780
08969/A	Soffietto Scatola Filtro Diam. 80 Lumgh. 160	3357205203
08969/B	Soffietto Scatola Filtro	3257205204
08975	Elastico Serbatoio Maico	3362002404



☆ 04975/A



☆ 04991



☆ 06903



☆ 06904



☆ 07985



☆ 07986



☆ 04937



06996/B



05962/A



01507



04999



☆ 06902



☆ 08968/A



☆ 08968



06936



08975



☆ 08969/A



☆ 08969/B

<i>Articolo</i>	<i>Descrizione</i>	<i>Simile al Nr. Orig.</i>
01608/A	Paio Manopole Magura Nero	
01608/A-R	Paio Manopole Magura Rosso	
01803	Parastrappi Grimeca Diam. 145	149.16.016.0.9
08969	Soffietto Scatola Filtro Maico 250-400	343

MALAGUTI

<i>Articolo</i>	<i>Descrizione</i>	<i>Simile al Nr. Orig.</i>
10990	Tampone Battuta Cavalletto F10-F12-F15-Centro	07206400
10991	Manic. Scat.Filtro F10-F12-F15-Centro Base 93-94-SI-Crosser	07601200
10992	Manic.Scat.Filtro Carb.Dell'orto F10-F12-F15-Centro SI-	07601300
10993	Manic.Scat.Filtro Carb.Tk F10-F12-Centro Base 93-94-SI	07601100

MALANCA

<i>Articolo</i>	<i>Descrizione</i>	<i>Simile al Nr. Orig.</i>
00921	Cappuccio A Pipa	
01546/A	Coprileva Cambio	
01562	Copripedale Diam. Interno 14 - Marchio Malanca	
01567	Coprileva Messa In Moto	
01568	Copripedale	
03944	Boccola Ancoraggio Serbatoio Al Telaio	
04999	Cappuccio Candela In Silicone	



☆ 01608/A
01608/A-R



08969



☆ 01803

MALAGUTI



10990



10991



10992



10993

MALANCA



01568



04999



☆ 01546/A



☆ 01562

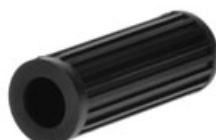

01567



☆ 03944



00921

<i>Articolo</i>	<i>Descrizione</i>	<i>Simile al Nr. Orig.</i>
04986	Calotta Forcella Meccanica Diam. 28	000533039
04987	Calotta Forcella Diam. 28	000533002
04988	Calotta Forcella Diam. 32	FI0031001
04989	Calotta Forcella Diam.35	FI0051001
06938	Calotta Forcella Diam. 34	
06946	Calotta Forcella Diam.30	FI0331001
06947	Calotta Forcella Diam.38	FI0521001
07905	Paio Soffietti Forcella Diam.35/48 Lungh.280	
07906	Paio Soffietti Nero Diam.35/48 Lungh.280	
07906-A	Paio Soffietti Blu Diam.35/48 Lungh.280	
08960	Paio Calotte Forcella Diam.30	1044010020
08961	Paio Calotte Forcella Diam.32	1236010001
08962	Paio Calotte Forcella Diam.35	1005010020
08963	Paio Calotte Forcella Diam.38	1052010020
12925	Guarnizione Ornamentale Ammortizzatori Posteriori	0005333003

MATCHLESS

<i>Articolo</i>	<i>Descrizione</i>	<i>Simile al Nr. Orig.</i>
00545	Paio Copripedali Guidatore Diam.13 Dx + Sx	
00854	Premistoppa Aste Valvole Inf.	
00855	Premistoppa Aste Valvole Sup. 28x18x15	
00855/S	Premistoppa Aste Valvole Superiore	

MINARELLI

<i>Articolo</i>	<i>Descrizione</i>	<i>Simile al Nr. Orig.</i>
01567	Coprileva Avviamento Foro Cieco Diam.12	2401580000
06954	Manicotto Carburatore Diam.36	242020
08911	Manicotto Carburatore Diam. 28	
10937	Manicotto Carburatore Motore Orizzontale Scooter	
10940	Gommino Cablaggi Booster	
10969	Manicotto Carburatore Motore Orizzontale Cy50	4CUE3550000
Articoli Non Figurati		
P/346	Paraolio Htcyl 38 X 20 X 7 Booster	



<i>Articolo</i>	<i>Descrizione</i>	<i>Simile al Nr. Orig.</i>
00575	Copripedale Guidatore Foro Diam.14	
00575/A	Copripedale Mi-Val Foro Diam.14	
01515	Coprileva Cambio	
01516	Coprileva Avviamento	
01841	Parastrappi Trapezoidale Per Ciclomotore	
02864	Paraolio Forcella	
02996	Passacavo Fanalino Posteriore	
03937	Protezione Uscita Cavo Candela 48 Cc	
03965	Guarnizione Foderi Forcella 34 X 36	

MONDIAL

<i>Articolo</i>	<i>Descrizione</i>	<i>Simile al Nr. Orig.</i>
00544	Paio Copripedali Guidatore Dx + Sx 125 Cc.	
00544/A	Paio Copripedali Guidatore Dx + Sx 160-200 Cc.	
00553	Coprileva Selettore Cambio 200 Cc. Foro Diam.8 Lungh.48	
00596	Coprileva Selettore Cambio 160 Cc. - Sogno	
00657/57/A	Paio Manopole Diam.22-24	
02863	Guarniz. Asta Frizione 125-175 Sport-Turismo	
03906	Boccola Forcella Marzocchi 30 Mm Per Mondial	51712182

MORINI

<i>Articolo</i>	<i>Descrizione</i>	<i>Simile al Nr. Orig.</i>
00521	Copripedale Guidatore In Pvc	30.01.22.
00521/A	Copripedale Guidatore In Gomma	30.01.22
00528	Coprileva Selettore Cambio	
00631/32	Paio Manopole Morini	
00832	Parastrappi 175 Cc.	
00832/A	Parastrappi 175 Cc. 2^ Serie	
00912/A	Soffietto Sospensione Post. 125 Cc. Diam. 50 Mm. 11 Spire	
00912/B	Soffietto Sospensione Anteriore 9 Spire	



★ 00575/A



★ 00575



★ 01516



★ 01515



★ 01841



★ 02864



★ 02996



★ 03937



★ 03965

MONDIAL



★ 00544/A



★ 00544



★ 00657/57/A



★ 00596



★ 00553



★ 02863



★ 03906

MORINI



★ 00521/A



★ 00521



★ 00631/32



★ 00528



★ 00832/A



★ 00832



★ 00912/A



★ 00912/B

<i>Articolo</i>	<i>Descrizione</i>	<i>Simile al Nr. Orig.</i>
00912	Soffietto Sospens. Post. 125 Cc. Diam. 60 Mm. 8 Spire	
00993	Tampone Arresto Cavalletto 125 Cc.	
01511	Coprileva Selettore Cambio 175 Cc.	
01543/A	Copripedale Guidatore diam. 14 Mm - Lungh. 104 Mm	
01558	Coprileva Avviamento 175 Cc. Foro Diam.14 Mm. Lungh.70 Mm.	
01569	Coprileva Avviamento Diam.14 - Corsarino	
01578/B	Copripedale Guidatore	
01805	Parastrappi Ruota Posteriore Sbarazzino 98 Cc.	
01816	Parastrappi Tresette Sprint	
01821	Parastrappi Corsaro - 2 Pezzi -	
01838	Parastrappi Mozzi Grimeca Diam.83	
02851	Guarnizione Paraolio Perno Avviamento Diam. 14 X 2 Mm.	
02874	Coperchio Di Tenuta Per Presa Diretta	
02889	Anello Tenuta Condotti Lubrificazione T-Gt-Super Sport	
02960	Anello Paraolio Forcella (= Or 00365)	
03894	Anello Di Tenuta Nel Castelletto Distribuzione 175 Cc.	
03895	Anello Di Tenuta Lubrificazione Albero Distribuzione 175 Cc.	
03896	Guarnizione Passaggio Olio Pompa A Distribuzione 175 Cc.	
03964	Guarnizione Di Fine Canotto Forcella Diam. 34 Mm.	
04930	Tampone Arresto Leva Avviamento Corsaro	
05858	Guarnizione Passaggio Olio Cilindro 175cc.Gt (11,4x5x2)	
10944	Calotta Verlicchi Per Corsarino	

MOSQUITO

<i>Articolo</i>	<i>Descrizione</i>	<i>Simile al Nr. Orig.</i>
00646	Paio Manopole Bmg 48 Cc.	
00870	Guarniz. Per Tappo Serbatoio Benzina Mosquito Diam. 24x33x3	
00872	Guarnizione Carter Diam. 14 X 9	
00872/A	Guarnizione Motore 38 Diam. 14 X 9	
00873	Guarnizione Carter Diam. 28 X 20	
00875	Guarnizione Per Sospensione Diam. 16 X 10	
01543	Copripedale Guidatore Foro Diam.12	
02860	Guarnizione Per Volano 38/B	
02885	Guarnizione Con Molla Per Volano 3B 2a Serie	
02894	Guarnizione Lato Ruttore 38/B	
03920	Tampone Fine Corsa Ritorno Leva Avviamento	



★ 00912



01543/A



★ 01558



★ 01578/B



★ 01805



★ 01816



★ 01821



★ 02874



★ 03895



★ 03964



★ 00993



★ 04930



★ 03896



★ 02889



★ 02851



★ 02960



★ 03894



★ 05858



★ 01838



★ 10994



★ 01511



01569

MOSQUITO



★ 00646



★ 01543



★ 02885



★ 00870



★ 00872/A



★ 00872



★ 00873



★ 00875



★ 02860



★ 02894



★ 03920

<i>Articolo</i>	<i>Descrizione</i>	<i>Simile al Nr. Orig.</i>
00846	Parastrappi Ruota Posteriore Diam. 24x10x7 Mm.	
00847	Parastrappi Ruota Posteriore Diam. 20,5x11,5x7 Mm.	
01513	Copripedale Guidatore Imperiale 125 Cc. Foro Baionetta	3219
01536	Coprileva Cambio	
01547/A	Coprileva Leva Messa In Moto - Foro Diam. 13 Mm. - 125 Sprite /250 Barracuda	M149
03943	Paracolpi Ritorno Cavalletto Imperiale 125 Cc.	3149
03944	Gommino Fissaggio Serbatoio Imperiale	3182
03997	Anello Passacavo Volano Magnete	
05866	Guarnizione Sulla Mandata Pompa Olio Imperiale 125 Cc.	3021
06885	Anello Tenuta Olio Asta Comando Frizione Imperiale 125 4t.	
06887	Passacavo Custodia Pignone Catena 125 Cc.	
06888	Anello Di Tenuta Mandata Olio 125 Cc.	3011
06889	Paraolio Imperiale 125 4t.	
06890	Anello Di Tenuta Olio Su Albero Preselettore Cambio 125 Cc.	

MOTOM

<i>Articolo</i>	<i>Descrizione</i>	<i>Simile al Nr. Orig.</i>
00531	Coprileva Avviamento Mod.51 Foro Diam.9 Lungh.65	
00638	Paio Manopole Diam.24 Prima Serie	
00638/A	Paio Manopole Diam. 24	25546
00841	Parastrappi Ruota Posteriore Delfino 160 Cc.	
01501	Gomma Pedali Prima Serie	
01537	Copripedale Guidatore 98 Cc. Foro Diam. 17 Mm.	
01537/A	Copripedale Guidatore 98 Cc. 1959 Foro Diam. 13 Mm.	
01811	Parastrappi Ruota Motom Pegaso 48 Cc Sport	
01822	Parastrappi Mod.51 - Diam.20x7x9,5	
01853	Guarnizione Motore 48 Cc. Lato Comando Frizione	
01853/A	Guarnizione Motore 48/C-51	
01854	Guarnizione Motore Pegaso 48 Cc.	
01855	(E)Guarnizione Motore 48 Cc. Lato Trasmissione	
01855/A	Guarnizione Motore Lato Trasmissione 48/C-51	
01856	Guarnizione Paraolio Motore 48 Cc. Sul Coperchio Laterale	
01987/A	Anello Supporto Motore	
02945	Paracolpo Forcella Anteriore 48 Cc.	
02997	Guarnizione Tappo Serbatoio Benzina 48 Cc.	
03922	Guarnizione Flangia Attacco Carburatore	
03924	Soffietto Forcella Diam. 21/30 8 Spire Lungh.120	
03926	Tampone Elastico Per Forcella Posteriore	
04898	Anello Di Guarnizione Per Sede Punterie L-L1/51	
05898	Anello Di Tenuta Sede Punterie Modello 51 Diam. 11,4 X 2,8	



☆ 01547/A

☆ 01513

☆ 01536

☆ 03943

☆ 03997

☆ 03944



☆ 00846

☆ 00847

☆ 05866

☆ 06885

☆ 06887

☆ 06888

☆ 06889

☆ 06890



☆ 00638/A

☆ 00638

☆ 00531

☆ 01501



☆ 01856

☆ 01537/A

☆ 01537

☆ 03924



☆ 04898

☆ 05898

☆ 01853/A

☆ 01853

☆ 01854

☆ 01855/A

☆ 01855

☆ 00841



☆ 01811

☆ 01822

☆ 03926

☆ 01987/A

☆ 02945

☆ 02997

☆ 03922

<i>Articolo</i>	<i>Descrizione</i>	<i>Simile al Nr. Orig.</i>
00522	Coprileva Freccia D'oro 3 Marce - Foro 14 -	
00538/A	Copripedale Guidatore Checca 98 Cc.- 350 Cc.Sport 1971	
00542	Copripedale Guidatore 125 Cc. 3 Marce 2 Tempi	
00542/A	Paio Copripedali Guidatore Dx + Sx - 125-150-175 Cc.	
00576	Coprileva Freno	
00577	Coprileva Selettore Cambio	
00639/40	Paio Manopole Diam. 22-24, Grigie	
00639/40-N	Paio Manopole Diam. 22-24, Nere	
00639/40-R	Paio Manopole Diam. 22-24 Rosso	
00818	Parastrappi Ruota Scooter Cgt - Csl	
00821	Parastrappi Ruota 20 X 9 X 6 Mm - 83 Cc	
00824	Parastrappi Ruota Ovunque Diam. 22 X 11,5 X 6	
00836	Parastrappi Frizione 175 Cc. Diam. 22 X 13 X 5	
00895	Guarnizioni Paraolio Albero Cambio Diam. 25x14x4,5	
00895/A	Guarnizione Stelo Valvola Cambio	
00896	Guarnizione Paraolio Albero Motore Diam. 28x16x4,5 Mm.	
00896/A	Guarnizione Paraolio Albero Motore 350 Cc.	
00897	Guarnizione Paraolio Albero M/Moto Diam. 26x18x4,5 Mm.	
00994	Guarnizione Tappo Serbatoio Benzina Diam. 47x37x3	
00996	Soffietto Molleggio Anteriore	
01545	Paio Copripedali Guidatore 83 Cc. E Liberty - Dx E Sx	
01617/A	Paio Manopole Comandi Tommaselli Daytona - Nero	
01617/A-P	Paio Manopole Comandi Tommaselli Daytona - Para	
01617/A-R	Paio Manopole Comandi Tommaselli Daytona - Rosso	
01801	Parastrappi 175 Cc. Csta Tipo America - Centomila 29x10x7	
01802	Parastrappi 175 Cc. Cs Sport - Cgst - 250 Cc. Raid	
01895	Guarnizione Per Prigionieri Testa Mm. 9 X 2,5	
01896	Guarnizione Paraolio Albero Motore Diam. 24x34x4 Mm.	
01926	Passacavo Carter	
01927	Premistoppa Sull' Albero Comando Frizione	
01959	Soffietto Mv Pullmann	
02869	Guarniz.Sez.Rettang.Tenuta Coperto Filtro Diam.64x60x2	
02872	Boccola Attacco Ammortizzatore 175 Cc. Diam. 34 X 16	
02887	Guarnizione Di Tenuta Stelo Valvola 175 Cc. Cs 1957	
02998	Cuffia Portastrumenti Mv 350 Cc Ipotesi - Sport - Gt	
04892	Guarnizione Asta Frizione 83 Cc. Rapido 125 Cc. 4 T.	
05948	Elastico per Serbatoio - Lungh.170 mm.	21321055000
05961	Boccola Ancoraggio Serbatoio	
05965	Guarniz. Attacco Carburatore 250-350-350 Sport - Scrambler	
05999	Raccordo Isolante Carburatore 750 - 750 Gt.	
06884	Raccordo Isolante Carburatore 750 - 750 Gt.	

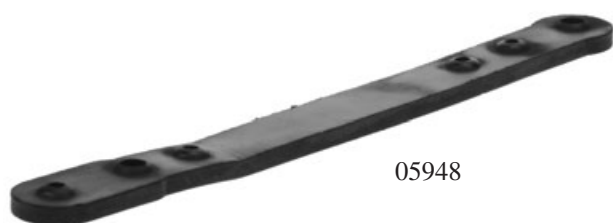

05948



★ 00522



★ 00538/A



02998



★ 00542



★ 00542/A



★ 00639/40
00639/40-N
00639/40-R



★ 01545



★ 00818



★ 00821



★ 00824



★ 00836



★ 00895/A



★ 00895



★ 02887



★ 01896



★ 00576



★ 00577



★ 02872



★ 01802



★ 05961



★ 02869



★ 00994



★ 06884
05999



★ 05965



★ 01801



★ 00896/A



★ 00896



★ 00897



★ 01926



★ 04892



★ 01927



★ 01895



★ 00996



★ 01959



★ 01617/A
01617/A-P
01617/A-R

<i>Articolo</i>	<i>Descrizione</i>	<i>Simile al Nr. Orig.</i>
01609/M	Paio Manopole 22-26 - Etz 125-150 251-301	
02536	Coprileva Cambio Etz 125/150 251/301	06-47.050
02537	Coprileva Avviamento Etz 125/150 251/301	05-46096
09985	Paio Soffietti Forcella Mz Tutti I Modelli	22-22.289
10910	Tampone Centrale Motore - Etz 125/150 251/301	22-20.032
10911	Tampone Serbatoio Etz 125/150 251/301	30-27.040
10912	Tamponcino Etz 125/150 251/301	16-31.023
10913	Cappuccio Etz 125/150 251/301	30-34.714

NSU

<i>Articolo</i>	<i>Descrizione</i>	<i>Simile al Nr. Orig.</i>
03927	Manicotto Aspirazione	

PARILLA

<i>Articolo</i>	<i>Descrizione</i>	<i>Simile al Nr. Orig.</i>
00411/12	Paio Ginocchiere Dx E Sx	
00543	Paio Copripedali Guidatore Sx+Dx	
00543/B	Paio Copripedali Guidatore Foro Diam.13 Sx+Dx	
00622	Paio Manopole Con Marchio Parilla Diam. 24-24	
00622/22/A	Paio Manopole Con Marchio Parilla Diam. 22-24	



PARILLA

<i>Articolo</i>	<i>Descrizione</i>	<i>Simile al Nr. Orig.</i>
00528/A	Coprileva Cambio Parilla Diam. Int. 9 Mm. - 175 Cc.	
00543/A	Copripedale Guidatore Con Marchio Parilla	174443
01509	Coprileva Avviamento	
01852	Guarnizione Tappo Serbatoio Benzina	
02913	Paraolio Aste Valvole 175 Cc.	174862

PUCH

<i>Articolo</i>	<i>Descrizione</i>	<i>Simile al Nr. Orig.</i>
00697	Paio Manopole Ciclomotore Comandi Magura	
01596	Coprileva Avviamento Lungh.61 Foro Passante Diam.10	
01597	Coprileva Cambio	
01602	Paio Manopole 22-24 Comando Magura	
02503	Coprileva Freno	
02504	Copripedale Guidatore Puch Foro Ovale Cieco 15 X 8 L.108	
04999	Cappuccio Candela In Silicone	
06902	Tendicavo Comando Gas Magura	
06909	Cappuccio Raccordo Carburatore Scatola Filtro	050.10.1577
06912	Raccordo Carburatore Filtro	362.10.245
06914	Soffietino Copricavi Comando Magura	
06931	Tappo	
06932	Arresto Messa In Moto	

RUMI

<i>Articolo</i>	<i>Descrizione</i>	<i>Simile al Nr. Orig.</i>
00562	Copripedale Guidatore Foro 14	



☆ 00543/A



☆ 02913



☆ 01852



☆ 01509



☆ 00528/A

PUCH



01596



01597



☆ 02503



☆ 06931



☆ 06932



☆ 06909



02504



☆ 01602



☆ 06912



☆ 06902



☆ 00697



04999



06914

RUMI



☆ 00562

<i>Articolo</i>	<i>Descrizione</i>	<i>Simile al Nr. Orig.</i>
00508/B	Copripedale Guidatore Diam.14	2160
00619/20	Paio Manopole Sertum Diam.23/25 Nere - 250 Cc. VT	
00619/20GR	Paio Manopole Sertum Diam.23/25 Grigie	

STERZI

<i>Articolo</i>	<i>Descrizione</i>	<i>Simile al Nr. Orig.</i>
00532	Coprileva Selettore	
00533	Coprileva Guidatore Foro Cieco Diam. 14	
00534	Coprileva Passeggero Foro Piatto	

SUZUKI

<i>Articolo</i>	<i>Descrizione</i>	<i>Simile al Nr. Orig.</i>
01583	Coprileva Cambio Lungh.46 Foro Cieco Diam.8	
01586	Coprileva Avviamento Lungh.73 Foro Passante Diam.11	
01588	Coprileva Avviamento Lungh.58 Foro Passante Diam.9	
01680/SSF	Paio Manopole Fino Al 2007	
02623/SSF	Paio Manopole Dal 2007	
08971	Paio Calotte Forcella Diam.38 Rm 125-250	
08971/A	Paio Calotte Forcella Diam.43 Rm 250-465	
08989	Pattino Protezione Forcellone Serie Er	
09920	Paio Calotte Forcella Nere Diam.43	



☆ 00508/B



☆ 00619/20



☆ 00619/20GR

STERZI



☆ 00532



☆ 00533



☆ 00534

SUZUKI



01583



01586



01588



☆ 08989



02623/SSF



01680/SSF



☆ 08971
08971/A



☆ 09920

<i>Articolo</i>	<i>Descrizione</i>	<i>Simile al Nr. Orig.</i>
00547	Coprileva Avviamento 125 V30t>V33t - Vm1/2t - Vn1t -150v11/2/3t-Vb1t- 150gs Vs1/2/3/4/5	013973
00547/A	Coprileva Avviamento Px (Tutte) - 150 Vbb	241004-49642
00548	Copripedale Avviamento Mod.50 - 125cc. 1957 -	
00550	Coprileva Freno 98 Cc - 125 1948>1950 V1>V15t	002804
00551	Coprileva Leva Freno Mod. 125 V30t>V33t -Vm1/2t - Vn1t -150v11/2/3t-Vb1t- 150gs Vs1/2/3/4/5	013647
00551/A	Coprileva Freno 125 Vnb3/4/5/6t - Vnc - Vn12 Fino Al Telaio 30001 - 150 Vbb1/2t Vbc -150gl Vba - 150 Gs Vs5 - 160gs Vsb1 - 180ss Vsc - 180 Rally Vsd - 200 Rally Se	093100
00551/B	Coprileva Freno 50 V5ss - V5a1t Dal Telaio 92877 - 90 V9ss - 125 Vma1/2t - Vmb1	100426
00551/C	Coprileva Freno 50 - Px Pe - Pk - Colore Nero	162001-182051
00551/D	Coprileva Freno Dal '94 Pk-Px	266299
00578	Coprileva Avviamento 50 - 90 - 125 Primavera - Et3 - Colore Nero	
00590/A/15	Copripedale Passeggero Foro 15	
00590/A/17	Copripedale Passeggero Foro 17	
00615-GR	Paio Manopole Grigie Diam.24 125 Cambio Bacc.1948-1950 Dal V1t Al V15t - 1951-1952 Dal V30 Al V33t -1953-1954 Dal Vm1 Al V2t -Utilitaria 1952-1957 Vn1 Al V2t	012153
00615/B-GR	Paio Manopole Grigie Mod. '50 - '55	
00615/C	Paio Manopole Nere Diam.24 - 150/'56 V1rt - 50 V5a1t - V5ss1t - 90 V9a1t - V9ss1t 125 Vma1t - Vna1/2t - Vnb12t Primavera -> '78 -	70577-028151
00615/C-GR	Paio Manopole Grigie Diam. 24 - 150/'56 V1rt - 50 V5a1t - V5ss1t - 90 V9a1t - V9ss1t 125 Vma1t - Vna1/2t - Vnb12t Primavera -> '78 -	70577-028151
00615/D	Paio Manopole Nere Diam.21 Dal 1957 Al 1966 - 125 Vnb3/4/5/6t 150 Vb1t -Vba1t -Vbb1t -150 Gl Vla1t - 160 Gs Vsb1t - 180 Ss Vsb1t	141925-060304
00615/D-GR	Paio Manopole Grigie Diam.21 Dal 1957 Al 1966 - 125 Vnb3/4/5/6t 150 Vb1t -Vba1t -Vbb1t -150 Gl Vla1t - 160 Gs Vsb1t - 180 Ss Vsb1t	141925-060304
00686	Paio Manopole Ciao	122184 - 122185
00687	Paio Manopole Nere Sprint-Sprint Veloce- 200 Rally	127556
00687/A	Paio Manopole Nere 50-90-125 Primavera - 125 Et3 Dal 1978 - 50 V5a2/3t V5b24t - 125 Vma2t -Vmb1	141924
00687/C	Paio Manopole Nere Px - Pe - 125 Vn12t - Vnx1t -150 Vlb1t - Vlx1t 180 Rally Vsd1t - 200 Vse1t - Vsx1t	141923
00888	Guarnizione Biconica Per Sospensione Anteriore	
00889	Guarnizione Tappo Serbatoio Miscela - Tutti I Modelli Esclosi 50/90/125 Primavera Et3	002319
00902	Cappuccio Candela	046741
00902/A	Cappuccio Candela 50/90/125 Primavera Et3	244395
00911	Soffiettino Asta Cambio a Bacchetta Vespa 125 1949-1950 - Colore Grigio -	012590
01533	Coprileva Freno Mod.125 1953-61 - 125 Vu1t 1953 - Vn1/2t 1954-1957 Vna1/2t 1956-1958 - Vnb1/2t 1959-1961	13647
01619/V	Paio Manopole per Vespa Px80 Vx81t - 200E Lusso Vsx1t 125 T5 VNX5T Dal 1985	178159
01638/V	Paio Manopole Per Vespa Pk 50 XI Nero	
01638/VR	Paio Manopole Per Vespa Pk 50 XI Rush Grigio	
02520	Coprileva Avviamento Serie Pk Tutti I Modelli	
02531	Coprileva Freno Vespa Cosa 125/150/200 Cc	228793



★ 00547



00547/A



★ 00551/A



★ 00551



★ 00550



★ 01533



★ 00548



00551/B



00551/C



00551/D



00578



★ 02520



★ 02531



★ 00590/A/15
00590/A/17



★ 01619/V



★ 00615/B-GR



00615/C-GR
00615/D-GR



00615/C
00615/D



★ 00686



00687/A



★ 00687
00687/C



★ 00615-GR



01638/V



01638/VR



★ 00911



★ 00888



00889



00902/A



00902

<i>Articolo</i>	<i>Descrizione</i>	<i>Simile al Nr. Orig.</i>
00903	Cappuccio Alta E Bassa Tensione Motore 125/1951-57 -150/58	016518
00945	Cappuccio Tenuta Fra Diaframma E Raccordo Immissione 1951-54 1 -125 V1t>V15t V30t>33t - Vm1>2t - Vu1t Utilitaria	011249
00945/A	Cappuccio Tenuta Per Modello 125/1956-57 E 150/1956-58 125 Vn1t>2t Vespa 150 V11t>3t-Vb1t	022674
00948	Protezione Guaine Vespa 150 1956	015423
00950	PASSACAVO NERO PER COMMUTATORE	015098
00950-GR	Passacavo Grigio Per Commutatore	015098
00952	Tampone Per Ammortizzatore Mod. 1951-54 -125 V1t>V15t - V30t>33t - Vm1>2t - Vu1t Utilitaria	006359
00953	Tampone Superiore Per Ammortizzatore Mod. 1951-54 -125 V1t>V15t V30t>33t - Vm1>2t - Vu1t Utilitaria (Foro Laterale Piccolo)	
00979	Cappuccio Prot. Grigio Guaine Al Manubrio Largh. 28 Mm. 125 V30t>V33t - Vm1/2t -Vu1t -Vn1/2t - 150 V11/2/3t -150 Gs Vs1t	015366
00979/C	Cappuccio Protezione Guaina Manubrio Grigio	
00980	Selletta Ammortizzatore Per Manubrio Modello 1954-55	015212
00982	Guarnizione Per Fanalino Post. Mod. 1951/53	
00986	Tampone Battuta Cavalletto	
00987	Passacavo Sulla Scocca - 1°Serie 1950 - 125 -150 1948>58 Per Modelli Cambio A Bacchetta 98-125 1948 Al Commutatore Luci E Telaio	010217
00989	Tampone Di Scontro Traversa Motore 125 Cc. - Mod.1951 125 V1t>V15t V30t>V33t - 125 Vm1/2t-Vn1/2t -150 V11/2/3t-Vb1t-150 Gs Vs1/2/3/4/5t	014836
01657	Paio Manopole Nere Grillo	229741/229745
01658/V	Paio Manopole Grigie Pk 50 - 125/FI2 1990	266187
01659/V	Paio Manopole Cosa 125-150-200 Lx	228541
01660	Paio Manopole Grigie Sfera 50 Cc.	267205/267206
01677	(E)Paio Manopole Vespa Hp-V 50 Cc	274489-274489
01873	Anellino Fra Cambio E Messa In Moto Diam. 13x10x3,4 Mm.	
01898/A	Paraolio 40 X 20 X 6 Con Flangia Mm.60 Tacca Tonda	3/25180
01898/B	Paraolio 40 X 20 X 6 Con Flangia Mm.60 Tacca Quadra	2/84644
05899	Tegolino Paraolio 125 Cc. 1958-59-60	46803
06882	Guarnizione Depuratore 125cc.Mod.1960/61-150cc.Mod.1959/60	58364
07851	Guarniz. Ammortizz. Anteriore 125/1960-62-150/1961-62-Gs-60	
07852	Guarnizione Ammort. Posteriore 125/1960-62 E 150/1961-62	
07872	Serie Paraolio Carburatore 150 Cc. 2%	



★ 01657



01658/V



01659/V



★ 01660



01677



07872



01898/A



01898/B



★ 05899



★ 06882



★ 01873



★ 07851



★ 07852



★ 00945/A



★ 00945



★ 00979/C



★ 00979



★ 00982



★ 00980



★ 00950-GR



★ 00950



★ 00986



★ 00987



★ 00948



★ 00989



★ 00952



★ 00953



★ 00903

<i>Articolo</i>	<i>Descrizione</i>	<i>Simile al Nr. Orig.</i>
00915	Soffietto Aspirazione 150 Gl -Px 125 - Px 150 Vlx1 - Vnx1 - Vsx1 -Pe - Vnx5	181476
00941	Paio Piedini Cavalletto 125 I Serie - V30t/V33t (1950-1952)	
00941/A	Paio Piedini Cavalletto 125 Ii Serie - Vm1t/Vm2t (1953-1954)	
00941/B	Paio Piedini Cavalletto 125 Vn1/2t - 125u Vu1t Utilitaria 1953	
00941/C	Paio Piedini Cavalletto 125 '58/60 - 150 Gs Ii Serie - Vs2t/Vs3t/Vs4t (1956-1958) 150 Gs Iii Serie - Vs5t (1958-1961)	84227/84228
00941/D	Paio Piedini Cavalletto 125 - 150 1961-63 - Foro Mm 18	54146-54147
00941/E	Paio Piedini Cavalletto 50-90-125 Primavera >1971 -	101971/101972
00941/F	Paio Piedini Cavalletto 50-90-125 Primavera - 125 ET3 Dal 1972	135387/135388
00941/G	Paio Piedini Cavalletto Serie Px-Pe Fino Al 1979	174919
00941/H	Paio Piedini Cavalletto Px - Pe Dal 1980 - Serie Pk	176166
00944	Guarnizione Portafaro Vespa 125 Cambio a Bacchetta V15T 1951-'52 - V30T>V33T	14229
00944/A	Guarnizione Portafaro Vespa 125 1953>1957 VM1>2T - VN1>2T	018855
00945/B	Cappuccio Depuratore 50-90-125 Primavera - Et3	71813
00948/B	Manicotto Protezione Guaine al Telaio e Commutatore Luci 125 1951-57 V30>33T - VM1>2T - U - VN1>2T - Vespa 150 1954-58 VL1>3T - GS VS1	018937
00948/C	Manicotto Protezione Guaine Al Telaio	
00949	Manicotto Protezione Asta Comando Rubinetto Benzina 1954-1955 - 125 V30t>33t-Vm1t>2t - Vespa 150 V11t>3t- Vb1t-Vs1t>5t	
00951	Tacchetto Di Scontro Sportello Ispezione Carburatore	011760
00977	Cappuccio Per Asta Rubinetto Benzina Modello 1954-55	
00978	Cappuccio Per Dado Ad Alette Tappo Serbatoio Benzina 1954-1955 125 V30t>33t-Vm1t>2t - Vespa 150 V11t>3t- Vb1t-Vs1t>5t	
02952	Cappuccio A Cono Per Intermittenza	
02953	Manicotto Astina Serbatoio	
02955	Cappuccio Alta E Bassa Tensione 150 Cc. 1955-58 - V11t>3t - Vb1t - Gs Vs1t>5t	022694
02955/A	Cappuccio Presa Alta Tensione 150 Cc. 1959-61 - 150 GL 1963/64 - 180 Rally	48525
02956	Ammortizzatore Inferiore Diam 32 X 14 X 16	057012
02957	Silentblock Ammortizz. Anteriore Parte Super.Diam.24x14x10	
02958	Tampone Gomma Sulla Sella Mod. Gs 1955-61- V11t>3t - Vb1t - Gs Vs1t>5t	024722
02959	Tampone Traversa Motore Mod. 125/1955-57 125 Vn2t - 150 V11t>3t Vb1t - Vgl1t E 15ogs/1955-58 Vs1>5t	040840
02961	Boccola Supporto Braccio Motore Mod. 1953-54	



02955/A



☆ 00941/A

☆ 00941/B

☆ 00941/C

00941/D



00941/E

00941/F

☆ 00941/G

00941/H



☆ 00941

☆ 00948/B

☆ 00948/C

☆ 00949

☆ 00951

☆ 00977

☆ 00978



☆ 00944/A



☆ 00944



00945/B

00915

☆ 02956

☆ 02957



☆ 02952

☆ 02953

☆ 02955

☆ 02958

☆ 02959

☆ 02961

<i>Articolo</i>	<i>Descrizione</i>	<i>Simile al Nr. Orig.</i>
00982/A	Guarnizione Fanalino Posteriore 125 Vna2t - 150 1958>60 Vba1t>110485 150 Gs Vs4-5t >0087589	021085
00983	Boccola Traversa Motore Mod. 1951	017100/1
00983/A	Silentblock Motore 28x14x16 Mod.1953-54	
00990	Guarnizione Tra Supporto E Scocca Vespa Cambio A Bacchetta V1>15t 1951>1952 V33t>228595	016955
01900	Piastrina Chiusura Cofano 125 Vm1/2t - Vn1/2t - 1953>57 - 150 V11/2/3t - Vb1t 1954>58	018946
01962	Guarnizione Di Base Contachilometri 125 1951>57 V30T>33T - VM1>2T - VN1>2T 150 1954>57 VL1>3T	015602
01962/A	Guarnizione Di Base Contachilometri 150 1957>58 Vb1t - 150 Gs 1955>58 Vs1t>4t	042009
01963	Passacavo Diam.11	
01963-GR	Passacavo Diam. 11 - Grigio	
01964	Passacavo Diam.8,5	
01964-GR	Passacavo Diam. 8,5 Grigio	
01986	Guarnizione Clackson Grigio Spessore 2 Mm - 125 V15t -Vm1/2t V30t>V33t - Vu1t -Vn1/2m -Vna1/2t - Vnb1/2/3/4/5/6t	03033
01986/A	Guarnizione Clackson Grigio - Spessore 4 Mm - 125 Vnc1t - 150 Vnl2 Dal 30001 - 150 GI Vla1t - 180 Ss Vsc1t	70614
01986/A-N	Guarnizione Clackson Nero - Spessore 4 Mm - 125 Vnc1t - 150 Vnl2 Dal 30001 - 150 GI Vla1t - 180 Ss Vsc1t	70614
01986/B	Guarnizione Clackson Nero - 50 V5A1T - V5SS1T - 90 V9A1T - V9SS1T -125 VNB2T DAL 4718 - VNC1T - 150 VBB1T DAL 32070 -VBC1T	70615
01986-N	Guarnizione Clackson Nero Spessore 2 Mm - 125 V15t -Vm1/2t - V30t>V33t Vu1t -Vn1/2m -Vna1/2t - Vnb1/2/3/4/5/6t	003033
02950	Guarnizione Tra Supporto E Scocca 125 V33t 228596> Vm1-2t - Vn1-2t 150 V11-2-3t - Vb1t125 Vn1/2t	040317
02951	Cappuccio Bassa Tensione Mod.150 Cc. 1959-61	
02962	Boccola Attacco Sup. Ammortizz. Posteriore 125/1955-57 125 Vn2t - 150 V11t>3t Vb1t - Vgl1t E 15ogs/1955-58 Vs1>5t (Foro Laterale Grande)	040315
02963	Boccola Attacco Inferiore Ammortizzatore Posteriore 125 1948>1957	
02982	Cappuccio Presa Alta E Bassa Tensione 98 - 125 1948-1950> 87483 - 98 /125 1948-1952	
03892	Guarnizione Leva Frizione 125 ('58 - '59) - 150 ('59)	
03909	Passacavo Al Parafango 150 V11/2/3t -150 Gs Vs1/2/3/4/5 Fino Al 1957	023563
03911	Guarnizione Fanalino Posteriore 25 Vnb1t>5t - 150 Vba1t 110486> - Vbb1-2t - 160 Gs Vsb1	083055
03966	Tamponcino Per Manubrio e Staffe Conta/Km GS VS1T	26601217
03968	Supporto Sinistro Traversa Motore 125 VNA>VNB25 Telaio 015717 150 VBA>VB1M Telaio 42404	047947
03969	Supp. Destro Traversa Motore Mod. 1953-54 Diam. 30x14x21 Mm	
03970	Tampone Ammortiz. Posteriore 125/1958-62 E 150/1959-62	
03971	Supporto Destro Traversa Motore 125-150 1959	
03973	Guarniz.Passaggio Cavo Alta Tensione Gs 150 Vs1>Vs5t Fino Al 1962	024446
03976	Passacavo Passaggio Diam. 17 Tubo Benzina Gs 150 Vs1>Vs5t Fino Al 1962	
03977	Cappuccio Presa Bassa Tensione 150 VS1/2/3/4/5	026916

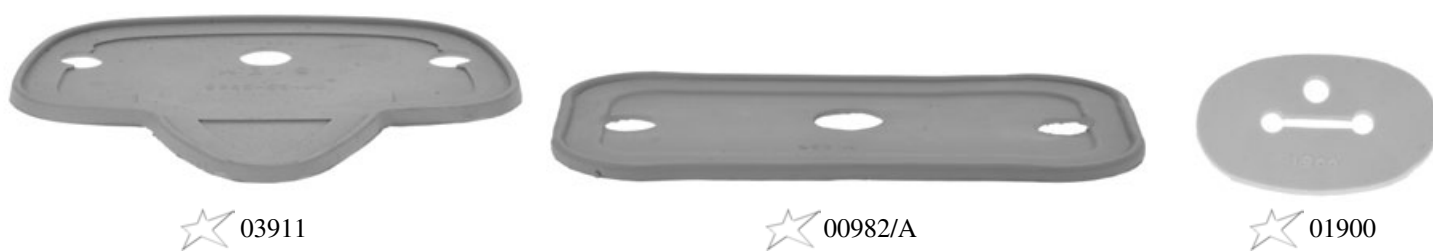

<i>Articolo</i>	<i>Descrizione</i>	<i>Simile al Nr. Orig.</i>
00995	Tacchetto Attacco Bauletto 125 A Bacchetta 71500> - V30>V33t - Vm1>2t - U - Vn1>2t Vespa 150 V11>3t -150 Gs Vs1t>5t	013821
01901	Guarnizione Rubinetto Benzina 125 1951>Tutti I Modelli Vespa 50-90-150-160-180-200 (Escluso Gs 150 Vs1t 009451>)	013836-610219M
01965	Soffietto Aspirazione Gs 150 Vs1/2/3/4/5t '55-61	24152
03912	Soffietto Carburatore Foro Piccolo 125 Vna1/2 - Vnb1 - 150 Vba1t Dal Telaio 97499	48345
04953	Serie Completa Listelli Pedane 50 V5a1t - 90 V9ss1t Fino Al 1970	47243-97237
05910	Tassello Per Feritoia Volano 50 Cc. Tutti I Modelli	110162
05911	Tassello Per Feritoia Volano 90-125 - Primavera - ET3 - PX	110586
05917	Tampone Sportello 50-90-125 Primavera-Et3	98669
05918	Tampone Sportello 50-90-125 Primavera-Et3	101783
05920	Tampone Sportello 50-90-125 Primavera-Et3	150566
05967	Paraspruzzi Parafango Anteriore Ciao	142779
06919	Tampone Forcella Anteriore Ciao	103699
06919/A	Tampone Forcella Px-Pe	176373
06957	Tassello Volano Magnete Ciao-Boxer-Bravo Fino Al 1975	102931
06957/A	Tassello Volano Magnete Ciao-Boxer-Bravo-Si Dal 1976	166504
07904	Tampone Scontro Cavalletto Px-Pe	174773
07908	Protezione Parafango Anteriore Ciao	143705
08970	Boccola Bobina Alta Tensione Ciao-Boxer-Bravo-Porter-Si	114164
08978	Cappuccio Protezione Cavo Candela Per Tutti Veicoli Piaggio	071671
08979	Cappuccio Isolante Bobina	073943
08980	Cappuccio Bassa Tensione	161125
08993	Tappino Sportello Pk	215339
08996	Paraspruzzi Posteriore Nero Pk	216989
09931	Cuffia Aspirazione Pk	178694
09979	Tampone Ammortizzatore Anteriore Pk	215499
09983	Tamponcino Sportello Pk 50-125 '90/91	232222
09997	Tampone Settore M/M Pk 50x1 - Pk 125x1	240753
10776	Paraolio Motore Lato Volano - Vedi Art. P/251 - Mm.62x20x6,5 160 Gs Vsb1t 1962>1964 180 Ss Vsc1t 1964>1968	078002
10851	Guarnizione Tappo Ciao	121234



★ 01965



★ 08996



09931



★ 05967



10776



06957/A



★ 06957



05910
05911



09979



★ 10851



★ 00995



★ 07908



06919/A



06919



07904



08979



08980



08978



01901



08970



08993



09983



05918



09997



05917



05920



03912



04953

<i>Articolo</i>	<i>Descrizione</i>	<i>Simile al Nr. Orig.</i>
03972	Tampone Carter Motore Vespa 125 (Escluso Primavera - Et3)- 150 - 160 - 180 - 200 - Px - Pe	46742
03974	Guarnizione Asta Rubinetto Benzina 125 Vna1/2 - Vnb1/2/3/4/5/6t - Vnc1t - Vnl2t Dal 300001 - 150 Vba1 - Vbb1/2t - Vbc1t - 150 Gl Vla1t - Vlb1t - 160 Gs Vsb1t 180 Ss Vsc1t - 180 Rally Vsd1t - 200 Rally Vse1t	47460/132538
03974-B	Guarnizione Asta Rubinetto Benzina Come 03974 ma in Colore Grigio	
03974/A	Passacavo Asta Rubinetto Benzina Px-Pe Dal 1983 Px Vnx2t 53220> - Vlx1t 430975> Vsx1t 138247> - Vbx1t 187801> - V8x1t 37552> - Vnx5t	194631
03978	Passacavo A Pipa Starter Acceleratore 125-150 1958> - 160 - 180-200 Rally - Px - Pe	48171
03979	Passacavo Volano Magnete 50-90-125 Primavera - ET3 - 125 VNA1>2T - VNB1>5T	46766
04902	Passacavo Cofano Vespa 125/150 Dal 58 Al 61 E Px 1978/1986	
04902-GR	Passacavo Grigio Cofano Vespa 125/150 Dal 58 Al 61 E Px 1978/1986	
04903	Tampone Appoggio Batteria 125/1960-62 E 150/1956-62	
04921	Dado Tappo Serbatoio Vespa 160 Gs E 180 Super Sport	93598
04927	Soffietto Aspirazione Carburatore 160 Gs Vsb1t 1962/64 - 180 Ss Vsc1t 1964/68	97366
04952	Tampone Ammortizzatore Anteriore 160 Gs Vsb1t 1962>1964 - 180 Ss Vsc1t 1964>1968	57997
04958	Soffietto Protezione Cavo Freno 125 Vnb3>6t - Vnc1t -Gt - Gtr - 150 VII>VI3t - Vb1t - Vba1t Vbb1>2t - Gs Vs1>Vs5t - Vla1t - Vlb1t - Vsb1t - Vsc1t - Vsd1t - Vse1t	76354
04959	Tampone Ammortizzatore Posteriore Tutti I Modelli Dal 1958	60536
04961	Anello Braccio Motore Lato Destro	59589
04962	Anello Braccio Motore Lato Sinistro	59588
04967	Tampone Scontro M/Moto 50-90 (3 Marce) - V5a1t>893029 - V5sa1t>69243 - V5ss1t V5ss2t>10379 - V9a1t>141512 - V9ss1t - V9ss2t - 125 Vma1> 2t Fino Al 1977	78578
04967/A	Tampone Scontro M/Moto 50-90-125 Primavera Et3 Dal 1978	
04968	Passacavo Comando Frizione 50-90-125 Primavera Et3	70219
04992	Soffietto Aspirazione 150 Vlb1t Sprint Veloce - 180 Rally Vsd1t 005256>	97366
04973	Guarnizione Tappo Serbatoio 50-90-125 Primavera Et3	71734
08964	Tassello Volano Magnete Px-Pe Con Lampeggiatori	133652
09930	Soffietto Aspirazione Px Arcobaleno Vlx1 - Vnx1 - Vsx1 - Pe - Vnx5	179803
09934	Serie Leve Nere Ciao-Si-Bravo	114222-114223
09962	Profilo Serbatoio Si Nero	446064
09963	Profilo Serbatoio Ciao Nero	228946
10988	Bussola Sportello Laterale Vespa 50 - 125 Fl	241235



03972



03974/A



03974
03974-B



★ 04902-GR



04902



★ 04903



★ 04921



★ 03978



03979



★ 04952



04959



★ 04961



★ 04962



★ 08964



04958



04967/A



04967



04968



04973



10988



★ 09963



★ 09962



09930



★ 09934



★ 04927



★ 04992

<i>Articolo</i>	<i>Descrizione</i>	<i>Simile al Nr. Orig.</i>
00878	Guarnizione Di Tenuta Fra Coperchio Frizione E Carter (Tipo Grande)	
00878/A	Guarnizione Coperchio Frizione 160 Gs Vsb1t 1962/64 - 180 Ss Vsc1t 1964/68	17781
01609/V	Paio Manopole Per Vespa	
01626/V	Paio Manopole Px - Pe - Arcobaleno 125 - 150 - 200	
01978	Guaina per Cavi Diam. 10x12 - Colore Grigio - al Kg.	
03935	Cappuccio Presa Bassa Tensione 125-'58/61 150-'59/62	48170
04901	Tappo Depuratore Aria 125 - 150 1958> 180 - 200 Rally - Px - Pe	50274
08999/P	Serie Strisce Nere Paracolpi Px - Pe	
09977	Paraspruzzi Si	
10902	Prot.Parafango Ant. Si Fl - Ciao Bravo Dal 1991	267798
11981	Coperchio Manubrio Px Arcobaleno Freno A Disco	581517



★ 00878
00878/A



09977



★ 10902



01609/V

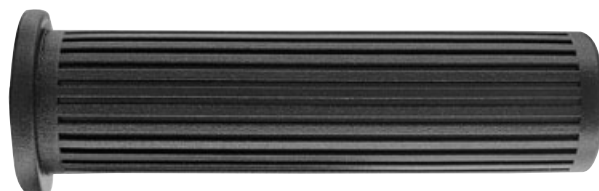

01626/V



11981



03935



04901



01978



08999/P

<i>Articolo</i>	<i>Descrizione</i>	<i>Simile al Nr. Orig.</i>
00984	Profilo Nero Per Sacche Fino Al '62 - Kit Per Una Vespa	51053
00984-GR	Profilo Grigio Per Sacche Fino Al 61 - Kit Per 1 Vespa	
00984-K	Profilo Per Sacche A Peso	
00984-KGR	Profilo Per Sacche A Peso Colore Grigio	
00984/C	Profilo Nero Per Sacche - Kit Per Una Vespa	56550-120793
00984/C-GR	Profilo Grigio Per Sacche - Kit Per Una Vespa	56550-120793
00984/C-K	Profilo Nero Per Sacche A Peso In Rotoli	
00984/CKGR	Profilo Per Sacche A Peso Colore Grigio	
00984/D	Profilo Per Sacche Serie Px-Pe - Kit Da 6 Spezzoni	161995
00984/D-B	Profilo Per Sacche Serie Px-Pe - Kit Da 6 Spezzoni Bianco	
00984/D-GR	Profilo Per Sacche Grigio - Px Pe - Kit Da 6 Spezzoni	
00984/D-K	Profilato Per Sacche A Peso Nero	
00984/D-KB	Profilo Bianco Per Sacche A Peso	
00984/DKGR	Profilo Per Sacche A Peso Colore Grigio	
00985	Kit Profili Pedane	56779
00985-K	Profilo Pedana A Peso	
00985/A	Kit Profili Pedane	94625
00985/A-K	Profilo Pedana A Peso	
00985/B	Kit Profili Pedane Serie Px-Pe	159829
00985/B-K	Profilo Pedana A Peso	
02925-K	Profilo Nero Per Targa Al Kg.	
02985	Profilo Per Pedane Confezione Completa Per Una Vespa	47243
02985-K	Profilo Pedana Rotoli A Peso	
02985/A	Profilo Per Pedane Confezione Completa Per Una Vespa	97237
03995	Guarnizione Coperchio Depuratore 150 Cc.	58853
03995-K	Guarnizione Coperchio Depuratore 150 Cc. Al Kg.	
08972	Profilato Nero Per Bauletto Px-Pe - Confezione 5 Pezzi	183546
08972/A	Conf. 5 Pezzi Profilato Nero Per Bauletto 50-90-125 Et3	
08972-K	Profilato Bauletto Nero Al Kg.	
08972-KGR	Profilato Bauletto Grigio Al Kg.	
08973	Pezzo Profilato Nero Per Scudo - Tutti I Modelli	
08973/5	Profilato Nero Per Scudo Tutti I Modelli - Conf. 5 Pz.	



00984/C-GR
00984/CKGR



00984/C
00984/C-K



00984/D-B
00984/D-KB



00984/D-GR
00984/DKGR



00984/D
00984/D-K



00984-GR
00984-KGR



00984
00984-K



00985/A
00985/A-K



00985/B
00985/B-K



00985
00985-K



08972 - 08972/A
08972-K - 08972-KGR



08973
08973/5



03995
03995-K

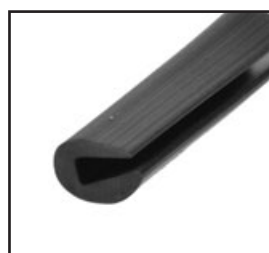

02925-K



02985/A

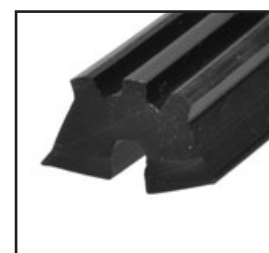

02985
02985-K

TUBETTO BENZINA

Misura	Descrizione	Confezione	Codice
6 x 9	Verde Trasparente	100 metri	01958/A-V
6 x 9	Nero	10 metri	01958/A/10
6 x 9	Verde Trasparente	10 metri	01958/A10V
6 x 9	Viola Doppio Strato Per Benzina Senza Piombo	10 metri	01958/A10S
6 x 13	Verde Trasparente	50 metri	01902-V
6 x 13	Nero	10 metri	01902/10
6 x 13	Verde Trasparente	10 metri	01902/10-V

SERIE PARAOLIO MOTORE

Descrizione	Codice
Carburatore 150 Cc. 2%	07872
Gs '62-64 Usb/1	Old Model 08853
Ss 180	Old Model 08853/A
125 '60/62-150 '61/62 (Motore + Carburatore)	08856
50-90-125 Primavera-Et3-Ape 50 Cc.	08865
125 Primavera	08865/A
50-90-125 Primavera-Et3 - Senza O.R.	08865/B
Ciao 2^ Serie	Old Model 08883
150 Sprint-Gl '59/64	09865
150 1966	09866
Ciao-Boxer-Bravo Monomarcia Senza Variatore	10867
Ciao-Boxer-Bravo Monomarcia Con Variatore	10868
Serie Px Fino All'83-125 Ts - Senza O.R.	10876
Serie Px Dall'83	10876/A
Serie Px Fino All'83-125 Ts - Con O.R.	10877
Serie Px Dall'87-T5-Serie Cosa	11867
Px 50 Xl-FI2-Ape 50 Tmp-Vespa Hp 4 M.	11872
Vespa Pk 50 - Xl - FI2	11872/B
Grillo Monomarcia	11883
Sfera Rst 125 - Vespa Et4	12856

PARAOLIO SINGOLI - CIAO - BOXER - BRAVO - SI

Misura	Descrizione	Simile al	Codice
VC 19 13 3	Per Ceppo Freno Posteriore	S8966	P/011
VC 22 13 4	Per Ceppo Freno Posteriore	S/17002	P/019
VC 22 16 3	Per Puleggia Motrice	S/8769	P/022
VC 23 17 3	Per Mozzo	103608	P/023
DC 24 15 5	Per Albero Motore Lato Volano	112978	P/027
VC 24 18 4	Per Albero Motore Lato Frizione	S/8771	P/035
SC 25 17 4	Per Coperchio Carter Motore	114469	P/038
SC 30 20 5	Per Mozzo Posteriore 2a Serie	131511	P/076
SC 35 22 6	Per Albero Ruota Posteriore 1a Serie	S/8752	P/115
TBY 35 25,7 7/9	Per Forcella Bravo - Si	2/123196	P/124

VESPA 50 - 90 - 125 PRIMAVERA - 125 ET3

Misura	Descrizione	Simile al	Codice
SC 32 19 7	Per Albero Motore Lato Volano	S/8720 - 15579	P/089
SC 37 27 7	Per Mozzo Ruota Posteriore	3/46699	P/130
SC 40 17 7	Per Mozzo Ruota Anteriore	S/8722	P/139
TC 40 24 7	Per Mozzo Ruota Anteriore	S/8708	P/148
SC 40 25 7	Per Mozzo Ruota Anteriore	128217	P/150
SC 47 22,7 7	Per Albero Motore Lato Frizione	S/8731	P/189

VESPA 125 TS DAL 1975

Misura	Descrizione	Simile al	Codice
HSCR 35 24 6	Per Albero Motore Lato Volano	158962	P/120
SC 40 17 7	Per Mozzo Ruota Anteriore	S/8722	P/139
SC 47 27 6	Per Mozzo Ruota Posteriore	130536	P/192
SCY 62 31 5,8/4,3	Per Albero Motore Lato Frizione	131102	P/256

VESPA P125X - P150X - PX 125 E - PX 150 E

Misura	Descrizione	Simile al	Codice
SC 27 19 6	Per Mozzo Ruota Anteriore	174887	P/046
HSCR 35 24 6	Per Albero Motore Lato Volano	158962	P/120
SC 47 27 6	Per Mozzo Ruota Posteriore	130536	P/192
SCY 62 31 5,8/4,3	Per Albero Motore Lato Frizione	131102	P/256

VESPA P200E

Misura	Descrizione	Simile al	Codice
SC 27 19 6	Per Mozzo Ruota Anteriore	174887	P/046
HSCR 35 24 6	Per Albero Motore Lato Volano	158962	P/120
SC 47 27 6	Per Mozzo Ruota Posteriore	130536	P/192
SCY 62 31 5,8/4,3	Per Albero Motore Lato Frizione	131102	P/256

<i>Articolo</i>	<i>Descrizione</i>	<i>Simile al Nr. Orig.</i>
01678	Paio Manopole Scooters Piaggio Per Tutti I Modelli	274489-274490
10959	Manicotto Integrale Carburatore Piaggio 50 : Free-Delivery-Nrg Rst-Mc2-Mc3 Extreme-Diesis-Liberty-Ntt-Sferarst50 - Sfera Maquillage2-Et2-Zip-Zip95 Zip Fast Rider-Zip Sp-Zip Rst-Zip Fast Rider Rst-Zip Fd- 80 Skr City	288029-436095
10966	Ventola Raffreddamento Tutti I Modelli Piaggio-Gilera	289338
10986	Ventola Frizione Scooters Piaggio Tutti I Modelli	287044
11940	Cinghia Pompa Miscelatore Automatico Piaggio 80 - 125 -150	431370
11948	Ventola Frizione Scooter Piaggio	480410
12979	Raccordo Carburatore Piaggio X9 - Beverly 200	484748
12980	Soffietto Carburatore Filtro Piaggio Liberty 50 - 125 - Leader 150	576773
12981	Raccordo Carburatore Piaggio Beverly 250	840949



10959



12979



12981



10966



12980

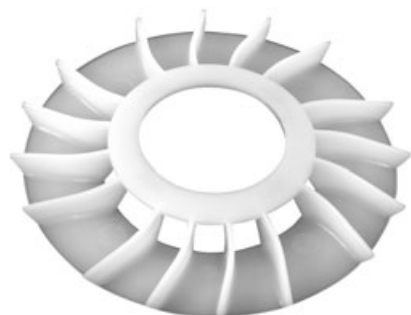

11948

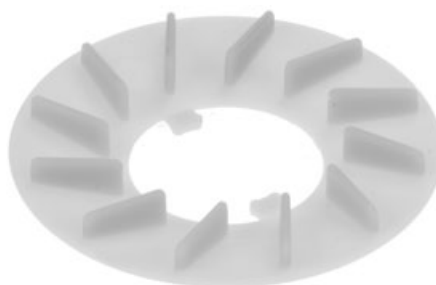

10986



11940



01678

<i>Articolo</i>	<i>Descrizione</i>	<i>Simile al Nr. Orig.</i>
12942	Deflettore Posteriore Sinistro Beverly 500	CM016901000C
12943	Deflettore Posteriore Destro Beverly 500	CM016902000C
12944	Pedana Anteriore Destra Beverly 500	CM01420400E8
12945	Pedana Anteriore Sinistra Beverly 500	CM01420300E8
12946	Pedana Anteriore Sinistra Beverly 250	CM014203000P
12947	Pedana Anteriore Destra Beverly 250	CM014204000P
12976	Deflettore Sx Beverly 125/250/400/500 Euro 3	CM008501000C
12977	Deflettore Dx Beverly 125/250/400/500 Euro 3	CM008502000C



12977



12942
12943



12976



12944
12945
12946
12947

<i>Articolo</i>	<i>Descrizione</i>	<i>Simile al Nr. Orig.</i>
01683	Paio Manopole Liberty	58582
01683-M	Paio Manopole Liberty - Marrone	
11959	Spoiler Liberty 50-125-150-200 Cc - 4 Tempi	575685000D
11978	Serie Strisce Pedane Liberty 50-125-150	573983
11979	Pavimento Liberti 50-125-150	576907000D
12940	Pavimento Liberty 125-150-200 4t	621204000D
12941	Coprimanubrio Posteriore Liberty 125-150-200 4t	621174000D



11979



12940



12941



11978



11959



01683
01683-M

<i>Articolo</i>	<i>Descrizione</i>	<i>Simile al Nr. Orig.</i>
11954	Deflettore Sinistro Liberty 50 Cc	5609440043
11956	Deflettore Destro Liberty 50 Cc	5609450043
11957	Deflettore Sinistro Liberty 125 Cc	5744720043
11958	Deflettore Destro Liberty 125 Cc	5744730043
11980	Coprimanubrio Posteriore Liberty 50-125-150 Vespa Et2	580978000D
11982	Deflettore Sinistro Posteriore Liberty 150	5744780043
11983	Deflettore Destro Posteriore Liberty 150	574770043
11984	Coprimanubrio Anteriore Liberty 50-125-150- Vespa Et 125-150	4272005
12936	Protezione Carena Destra Liberty 125-150-200 4t	CM0201010043
12937	Protezione Carena Sinistra Liberty 125-150-200 4t	CM201020043
12938	Deflettore Destro Liberty 125-150-200 4t	CM0200020043
12939	Deflettore Sinistro Liberty 125-150-200 4t	CM0200010043
12972	Deflettore Sx Liberty50 2t- 125 4t - 200 4t Euro 3	CM02000100EO
12973	Deflettore Dx Liberty 50 2/4t - 125/200 4t Euro 3	CM02000200EO
12974	Protezione Laterale Sx Liberty 50/2/4t- 125/200 4 T Euro 3	CM020102000P
12975	Protezione Laterale Dx Liberty50/2/4t - 125/200 4t Euro 3	CM020101000P



11957
11958



12936
12937



11982
11983



12974
12975



11954
11956



12938
12939
12972
12973



11984



11980

TUBETTO BENZINA

Misura	Descrizione	Confezione	Codice
6 x 13	Verde Trasparente	50 metri	01902-V
6 x 13	Nero	10 metri	01902/10
6 x 13	Verde Trasparente	10 metri	01902/10-V

SERIE PARAOLIO MOTORE

	Descrizione	simile al	Codice
	Sfera 50-80-Zip-Zip Fast Rider-Quartz-Free-Et2 - Vespa 50 Et2		11891
	Come Sopra (Prezzo Economico)		11891/AE
	Scooter Tutti I Modelli Raffr. A Liquido	498471	12852
	Tipo Economico Scooters Raffr.A Liquido		12852/AE
	Liberty 50		12854
	Hexagon 125/150		12855
	Sfera Rst 125 - Vespa Et4		12856
	Albero Motore Piaggio 50 Cc (2 Paraolio)		12860

PARAOLIO SINGOLI - SCOOTERS PIAGGIO

Misura	Descrizione	simile al	Codice
TC 28 18 7	Per Albero Motore Lato Volano	145597	P/179
TCRV 30 19 7	Per Albero Motore Lato Frizione	239391	P/327
SC 40 22 7	Per Albero Ruota Posteriore	239848	P/146
SC 47 30 6	Per Asse Ruota Posteriore	8717	P/195
KBC2 47 40 4	Per Puleggia Condotta	478269	P/328

MANICOTTI CARBURATORE

	Descrizione	simile al	Codice
	Sfera - Zip - Quartz - Vespa Et2 -Nrg - Free	436095	10959
	Hexagon 125/150 - Skipper 125/150	430206	11977

CINGHIE DI TRASMISSIONE

cm3	Modello	simile	Anno	Codice Standard	Codice Kevlar	Codice Doppia
50	Business 50			10964	10964/K	
50	Diesis 2T	436864	(01/>)	10964	10964/K	
50	Diesis 2T (oil pump belt)	286162	(01/>)	11924		
50	Fly 2T (oil pump belt)	286162	(05/08)	11924		
50	Fly 2T 50	82712R	(04/>)	11953	11953/K	
50	Fly 2T 50	842907	(04/>)	11965	11965/K	
50	Fly 4T	842907	(05/08)	11965	11965/K	
50	Fly 50				11988/K	
50	Free 50	430728	(92/00)	10996	10996/K	
50	Free Delivery	436864	(00/>)	10964	10964/K	
50	Free FL	436864	(02/>)	10964	10964/K	
50	Free FL	430728	(95/01)	10996	10996/K	
50	Free/FL/Delivery (oil pump belt)	286162	(92/>)	11924		
50	Liberty 2T	82712R	(06/08)	11953	11953/K	
50	Liberty 2T	480852/82712R	(97/05)	11953	11953/K	
50	Liberty 2T 50	480852/82712R	(97/03)	11953	11953/K	
50	Liberty 2T 50	82712R	(04/>)	11953	11953/K	
50	Liberty 2T PTT EU2	82712R	(04/06)	11953	11953/K	
50	Liberty 2T Rst	82712R	(04/06)	11953	11953/K	
50	Liberty 2T Sport	82712R	(06/08)	11953	11953/K	
50	Liberty 2T/Rst/Sport/PTT EU2	286162	(97/08)	11924		
50	Liberty 4T	480852/82712R	(00/03)	11953	11953/K	
50	Liberty 4T Rst	82712R	(04/08)	11953	11953/K	
50	Liberty 4T Sport	82712R	(06/07)	11953	11953/K	
50	Liberty 4T Sport Euro 3	82712R	(07/08)	11953	11953/K	
50	Liberty 50 le 4t	480852/82712R	(01/...)	11953	11953/K	
50	Liberty 50 le 4t	480852/82712R	(04/...)	11953	11953/K	
50	NRG 50	430728	(94/96)	10996	10996/K	
50	NRG Extreme	4386864	(99/01)	10964	10964/K	
50	NRG MC	436864/286162		10964	10964/K	
50	NRG MC? 50	430728	(94/97)	10996	10996/K	
50	NRG MC3	436864	(01/04)	10964	10964/K	
50	NRG MC? 50	4386864	(01/02)	10964	10964/K	
50	NRG Power DD	436864	(05/08)	10964	10964/K	
50	NRG Power DT	436864	(06/08)	10964	10964/K	
50	NRG Power PureJet 50	833982	(04/05)	10964	10964/K	
50	NRG PureJet	436864	(02/04)	10964	10964/K	
50	NRG Rst MC2 (DD)	436864	(98)	10964	10964/K	
50	NRG Rst MC2 (DT)	430728	(96/97)	10996	10996/K	
50	NRG/Rst MC2/Extreme/MC3/ PureJet/Power/DD/DT (oil pump belt)	286162	(94/08)	11924		
50	NTT	430728	(95/96)	10996	10996/K	

CINGHIE DI TRASMISSIONE

cm3	Modello	simile	Anno	Codice Standard	Codice Kevlar	Codice Doppia
50	NTT (oil pump belt)	286162	(95/96)	11924		
50	NTT 50	430728	(94/96)	10996	10996/K	
50	Quartz	431190/289432	(92/96)	11924		
50	Quartz (oil pump belt)	286162	(92/96)	11924		
50	Quartz 50	431190/289432	(92/96)	11924		
50	Runner 50				11950/K	
50	Sfera 50	431190	(95/97)	11924		
50	Sfera FL Rst	431190	(95/97)	11924		
50	Sfera II	286162		11924		
50	Sfera Maquillage 2	431190	(<94)	11924		
50	Sfera/Maquillage 2/FL Rst (oil pump belt)	286162	(91/97)	11924		
50	Typhoon 50	436864	(01/...)	10964	10964/K	
50	Typhoon X 50	436864	(01/...)	10964	10964/K	
50	Typhoon X-R	436864	(01/08)	10964	10964/K	
50	Typhoon X-R (oil pump belt)	286162	(01/08)	11924		
50	Vespa ET2	431190	(04/98)	11924		
50	Vespa ET2	431190	(97/01)	11924		
50	Vespa ET2	828223/82645R	(98/>)		11929/K	
50	Vespa ET2 (Injection) 50	828223/82645R	(97/00)		11929/K	
50	Vespa ET2 (oil pump belt)	286162	(97/05)	11924		
50	Vespa ET2 Injection	828223/82645R	(97/00)		11929/K	
50	Vespa ET2 Injection (oil pump belt)	480341	(97/00)		11988/K	
50	Vespa ET2 Injection (oil pump belt)	480135	(98/00)		11988/K	
50	Vespa ET4	828223/82645R	(00/05)		11929/K	
50	Vespa LX 2T	828223/82645R	(04/>)		11929/K	
50	Vespa LX 2T (oil pump belt)	286162	(05/08)	11924		
50	Vespa LX 4T	828223/82645R	(05/08)		11929/K	
50	Vespa LX 4T	828223/82645R	(04/>)		11929/K	
50	Vespa LXV 2T	82645R	(06/08)		11929/K	
50	Vespa LXV 2T (oil pump belt)	286162	(06/08)	11924		
50	Vespa S Special 2T	82645R	(07/08)		11929/K	
50	Vespa S Special 2T (oil pump belt)	286162	(07/08)	11924		
50	XR 50			10964	10964/K	
50	Zip (94-) 50		(95/96)	11924		
50	Zip 2000 (sp) 50				11929/K	
50	Zip 4T	828223/82645R	(00/08)		11929/K	
50	Zip Base	431190	(95/96)	11924		
50	Zip Base	286162	(92/96)	11924		
50	Zip Cat. 2T	286162	(00/08)	11924		
50	Zip Cat. 2T	828223/82645R	(00/08)		11929/K	
50	Zip Fast Rider	431190/286162	(93/99)	11924		

CINGHIE DI TRASMISSIONE

cm3	Modello	simile	Anno	Codice Standard	Codice Kevlar	Codice Doppia
50	Zip Fast Rider 50	431190	(93/99)	11924		
50	Zip Fast Rider/Rst	286162	(93/99)	11924		
50	Zip Fast/Rider/Rst	431190	(93/99)	11924		
50	Zip Rst	431190	(96/99)	11924		
50	Zip Rst	286162	(96/99)	11924		
50	Zip SP	431190	(96/00)	11924		
50	Zip SP	828223/82645R	(01/08)		11929/K	
50	Zip SP (oil pump belt)	286162	(96/00)	11924		
50	Zip SP (oil pump belt)	286462	(01/08)		11988/K	
80	Skr city	430719/431370	(99/..)		11928/K	
100	Fly 4T	82619R	(06/08)	11965	11965/K	
100	Free 4T 100	82619R	(02/>)	11965	11965/K	
100	Zip 4T	82645R	(06/08)		11929/K	
125	Beverly 125	829366/842009	(01/03)		11987/K	
125	Beverly Euro 3/Sport/MIC	842009	(07/08)		11989/K	
125	Beverly RST 125	842009	(04/>)		11989/K	
125	Carnaby	842009	(07/08)		11989/K	
125	Fly	841213	(05/08)		11930/K	
125	Hexagon 2T	431370	(94/99)		11928/K	
125	Hexagon GTX 4T	832023/841213	(00/...)		11930/K	
125	Hexagon gtx 4T 125	832023/841213	(00/...)		11930/K	
125	Hexagon LX 125	431370	(94/99)		11928/K	
125	Hexagon LX 2T	434812	(98/99)		11928/K	
125	Hexagon LX 2T (oil pump belt)	431370	(94/99)		11928/K	
125	Hexagon LX4 4T	484758	(98/>)		11988/K	
125	Hexagon LX4125	434812/825059	(98/99)		11988/K	
125	Liberty	484758	(98/99)		11988/K	
125	Liberty	825059	(00)		11988/K	
125	Liberty (Leader)	832023	(00/03)		11930/K	
125	Liberty 125	825059	(00)		11988/K	
125	Liberty 4T Sport/Euro 3	841213	(06/08)		11930/K	
125	Liberty Leader 125	832023/841213	(00/...)		11930/K	
125	Liberty PTT	841213	(06/06)		11930/K	
125	Liberty Rst 125	841213	(04/>)		11930/K	
125	Liberty Rst/Euro 3	841213	(04/08)		11930/K	
125	MP3	841213	(07/08)		11930/K	
125	Sfera FL 4T	434807/478547	(95/97)	11965	11965/K	
125	Sfera II125	434807			11929/K	
125	Skipper 125 2T (frame nr. till 14740)		231258	(95/97)		11928/K
125	Skipper 125 2T(frame nr. from 14741)		434812	(93/97)		11928/K
125	Skipper 125 4T	832023/841213	(00/>)		11930/K	
125	Skipper 125 LX 2T	434812	(98/99)		11928/K	

CINGHIE DI TRASMISSIONE

cm3	Modello	simile	Anno	Codice Standard	Codice Kevlar	Codice Doppia
125	Skipper 2T (from frame nr. 14741)	434812	(93/97)		11928/K	
125	Skipper 2T (till frame nr. 14740)	431258	(93/97)		11928/K	
125	Skipper 2T/LX 2T (oil pump belt)	431370	(93/99)		11928/K	
125	Skipper Leader 125		(00/...)		11930/K	
125	Skipper LX 2T	434812	(98/99)		11928/K	
125	Skipper ST 4T	832023/841213	(00/05)		11930/K	
125	SuperHexagon GTX 125	832023/841213	(00)		11930/K	
125	SuperHexagon GTX 4T	832023/841213	(01/>)		11930/K	
125	Typhoon 125				11928/K	
125	Vespa ET 4 125	434807/478547	(97/99)	11965	11965/K	
125	Vespa ET 4 Leader 125	832023/841213	(99/00)		11930/K	
125	Vespa ET4 (Leader)	832023/841213	(00/05)		11930/K	
125	Vespa GT 125		(03)		11930/K	
125	Vespa GT Granturismo/Euro 3	832023/841213	(03/08)		11930/K	
125	Vespa GTS Euro 3	841213	(07/08)		11930/K	
125	Vespa GTV	841213	(07/08)		11930/K	
125	Vespa LX 125	841213	(04/>)		11930/K	
125	Vespa LX/Euro 3	841213	(05/08)		11930/K	
125	Vespa LXV 4T Euro 3	841213	(06/08)		11930/K	
125	Vespa S Special Euro 3	841213	(07/08)		11930/K	
125	X7	841213	(07/08)		11930/K	
125	X8 125	841213	(04/>)		11930/K	
125	X8 Street Euro	841213	(06/07)		11930/K	
125	X8/Premium Euro 2	841213	(04/06)		11930/K	
125	X9 125	832023/841213	(01/02)		11930/K	
125	X9/Evolution/Euro 3	832023/841213	(01/07)		11930/K	
125	X-EVO	841213	(07/08)		11930/K	
125	Zip 4T	832023/841213	(00/06)		11930/K	
125	Zip 4T 125	832023/841213	(00/...)		11930/K	
125	Zip Leader 125				11930/K	
150	Fly	841213	(05/08)		11930/K	
150	Fly 150	841213	(04/>)		11930/K	
150	Hexagon 150	434812	(94/97)		11928/K	
150	Hexagon 2T	434812	(94/97)		11928/K	
150	Hexagon 2T (oil pump belt)	431370	(94/97)		11928/K	
150	Liberty	832023/841213	(99/03)		11930/K	
150	Liberty 150		(00/...)		11929/K	
150	Liberty Leader 150	832023/841213	(00/...)		11930/K	
150	Skipper 150 4T		(00/02)		11928/K	
150	Skipper 150 Lxt	434812	(98/99)		11928/K	
150	Skipper 2T (da tel. N. 14741)	434812	(93/97)		11928/K	
150	Skipper 2T (fino a tel. N. 14740)	431258	(93/97)		11928/K	

CINGHIE DI TRASMISSIONE

cm3	Modello	simile	Anno	Codice Standard	Codice Kevlar	Codice Doppia
150	Skipper 2T 150	431258	(94/97)		11928/K	
150	Skipper 2T 150	832023/841213	(94/97)		11930/K	
150	Skipper 2T/LX 2T (oil pump belt)	431370	(93/99)		11928/K	
150	Skipper Leader 150				11930/K	
150	Skipper LX 2T	434812	(98/99)		11928/K	
150	Skipper ST 4T	832023/841213	(00/05)		11930/K	
150	Vespa ET 4 150	832023/841213	(00/...)		11930/K	
150	Vespa ET 4 Leader 150		(00/>)		11930/K	
150	Vespa ET4	832023/841213	(99/05)		11930/K	
150	Vespa LX 150	841213	(04/>)		11930/K	
150	Vespa LX/Euro 3	841213	(05/08)		11930/K	
150	X8 Street Euro 2	841213	(06/07)		11930/K	
180	Hexagon 180 LXT 2T	484497	(98/...)		11928/K	
180	Hexagon GTX 4T	827639/832623	(00)			12988/D
180	Hexagon LXT 2T	484497	(98/99)		11928/K	
180	Hexagon LXT 2T (oil pump belt)	431370	(98/99)		11928/K	
180	Super Hexagon GTX 4T 4V 180	832623/840908	(00/>)			12988/D
180	SuperHexagon GTX 4T	827639/832623	(01/>)			12988/D
180	X9 Amalfi 180	832623/840908				12988/D
200	Beverly 200	828043/842011	(01/03)			12989/D
200	Beverly/Rst	828043/842011	(04/06)			12989/D
200	Carnaby	842011	(07/08)			12989/D
200	Liberty Rst 200	840908	(04/>)			12988/D
200	Liberty Rst/Euro 3	840908	(04/08)			12988/D
200	Liberty Sport/Euro 3	840908	(06/08)			12988/D
200	Vespa GT Granturismo	840908	(03/08)			12988/D
200	Vespa GT L 200	840908	(03)			12988/D
200	X8	840908	(04/06)			12988/D
200	X8 200	840908				12988/D
200	X9	832623/840908	(02/03)			12988/D
200	X9 200	832623/840908	(02/03)			12988/D
200	X9 evolution 200	832623/840908	(03)			12988/D
200	X9/Evolution	832623/840908	(03/>)			12988/D
250	Beverly (Carburator)	841851	(06/07)			12988/D
250	Beverly 250	841851	(04/>)			12988/D
250	Beverly Cruiser	841851	(07/08)			12988/D
250	Beverly IE Euro 3/MIC (Injection)	841851	(06/08)			12988/D
250	Beverly Rst (Carburator)	841851	(05/05)			12988/D
250	Beverly Sport	841851	(06/08)			12988/D
250	Beverly Tourer	841851	(08/>)			12988/D
250	Hexagon GT	495158	(98/99)		11928/K	
250	Hexagon GT 250	495158	(98/99)		11928/K	

CINGHIE DI TRASMISSIONE

cm3	Modello	simile	Anno	Codice Standard	Codice Kevlar	Codice Doppia
250	MP3	843963	(06/08)			12990/D
250	SuperHexagon GTX	495158	(00/>)		11928/K	
250	Superhexagon GTX 250	495158	(00/>)		11928/K	
250	Vespa GT 60 Euro 3	843963	(06/08)			12990/D
250	Vespa GTS	843963	(05/08)			12990/D
250	Vespa GTV	843963	(06/08)			12990/D
250	X7	843963	(07/08)			12990/D
250	X8	843963	(05/08)			12990/D
250	X9 (Honda)	496304	(00/03)		11990/K	
250	X9 250	496304/843963	(00)			12990/D
250	X9 250 quasar		(00)			12990/D
250	X9 Evolution (Piaggio)	843963	(04/07)			12990/D
250	X-EVO	843963	(07/08)			12990/D
400	Beverly i.e.	832738	(06/08)			12991/D
400	MP3	832738	(07/08)			12991/D
400	X8	832738	(06/08)			12991/D
400	X-EVO	832738	(07/08)			12991/D
500	Beverly	832738	(02/06)			12991/D
500	Beverly Cruiser	832738	(07/08)			12991/D
500	Beverly Euro 3	832738	(06/08)			12991/D
500	X9	832726	(00/02)			12991/D
500	X9 500	827826	(01/04)			12991/D
500	X9 EvolutioBS	832738	(03/08)			12991/D
500	X9 Evolution 500	832738	(03/>)			12991/D

ARI KITS PARAOLIO FORCELLA

cm3	Modello	Anno	Codice	Simile al
50	Free	92-99	ARI.075	269603
50	Liberty	97->	ARI.079	563238
50	NRG	->99	ARI.076	
50	NRG MC2 Ferrari	—————	ARI.075	
50	NRG Power DD	2004-2005	ARI.112	564236
50	NRG Power Purejet	2004-2005	ARI.112	564236
50	NTT	95-98	ARI.075	269603
50	ZIP SP H2O	99->	ARI.075	269603
50	ZIP-Fast Rider	93-97	ARI.075	269603
125	Beverly 125	2004-2005	ARI.061	497010/600268
125	Liberty	99	ARI.103	494770
125	Liberty 125 4T	2004-2005	ARI.133	494771 / 599201
125	Skipper	98->	ARI.112	564236
125	X 8 125 4T	2004-2005	ARI.061	497010/600268
150	Skipper	98->	ARI.112	564236

ARI KITS PARAOLIO FORCELLA

cm3	Modello	Anno	Codice	Simile al
200	Beverly	2001-2002	ARI.061	497010/600268
200	Liberty 200 4T	2004-2005	ARI.133	494771 / 599201
200	X 8 200 4T	2004-2005	ARI.061	497010/600268
250	Beverly 250	2004-2005	ARI.061	600268
250	X 9	2000->	ARI.061	497010
250	X 9 Evolution 150	2004-2005	ARI.061	497010/600268
460	Beverly 500	2004-2005	ARI.102	599267
460	X 9 500 Street	2004-2005	ARI.023	599501
460	X 9 Evolution 500	2004-2005	ARI.023	599501
460	X 9 Evolution 500 ABS	2004-2005	ARI.023	599501
500	X 9	2000->	ARI.061	497010

PIAGGIO GILERA

Articolo	Descrizione	Simile al Nr. Orig.
----------	-------------	---------------------

10959	Manicotto Integrale Scooters 50 Cc- Runner - Typhoon - Stalker - Storm - Easy Mov.	436095
10966	Ventola Raffreddamento Tutti I Modelli Piaggio Gilera	289338
11977	Manicotto Integrale Scooters Runner 125/180 - Typhoon 125-Skipper 125/150	430206



11977



10959



10966

TUBETTO BENZINA

Misura	Descrizione	Confezione	Codice
6 x 13	Verde Trasparente	50 metri	01902-V
6 x 13	Nero	10 metri	01902/10
6 x 13	Verde Trasparente	10 metri	01902/10-V

SERIE PARAOLIO MOTORE

Descrizione	simile al	Codice
Storm - Typhoon- Zip Easy Moving 50		11891
Come Sopra (Prezzo Economico)		11891/AE
Scooter Piaggio Tutti I Mod.Raffreddati A Liquido 498471		12852
Tipo Economico Scooters Piaggio Raffreddati A Liquido		12852/AE
Hexagon 125-150 Typhoon 125 498451		12855

MANICOTTI CARBURATORE

Descrizione	simile al	Codice
Runner 50 - Stalker 50 - Storm 50 - Typhoon 50 - Easy Moving 50	436095	10959
Skipper 125/150 - Typhoon 125 - Runner 125/180	430206	11977

CINGHIE DI TRASMISSIONE

cm3	Modello	simile al	Anno Standard	Codice Kevlar	Codice Doppia	Codice
50	DNA/GP Experience (oil pump belt)	286162	(00/07)	11924		
50	DNA/GP Experience 50	480852/82712R	(00/05)	11953	11953/K	
50	Easy moving 50	431190/286162	(95/...)	11924		
50	Ice 50	436864/186162	(01/...)	10964	10964/K	
50	Runner 50 dd/sp/lc	436864	(97/...)	10964	10964/K	
50	Runner purejet 50	436864/833982	(02/...)	10964	10964/K	
50	Runner SP	436864	(05/08)	10964	10964/K	
50	Runner SP Race	436864	(06/08)	10964	10964/K	
50	Runner SP Special Edition	436864	(07/08)	10964	10964/K	
50	Runner/SP/Race/FL/Poggiali/ Purejet/Race/SC (oil pump belt)	286162	(97/08)	11924		
50	Stalker	436864	(97/02)	10964	10964/K	
50	Stalker 50 base	436864/286162	(97/04)	10964	10964/K	
50	Stalker Euro 2/Special Sport	436864	(03/08)	10964	10964/K	
50	Stalker/Euro 2/Special Sport (oil pump belt)	286162	(97/08)	11924		
50	Storm Euro 2	436864	(07/08)	10964	10964/K	
50	Storm Euro 2 (oil pump belt)	286162	(07/08)	11924		
50	Typhoon X 50	430728	(93/99)	10996	10996/K	
50	Typhoon/X/XR (oil pump belt)	286162	(93/08)	11924		
50	Typhoon/XR	436864	(00/08)	10964	10964/K	
125	DNA 125	487170	(01/...)		11930/K	
125	DNA 4T	841213	(01/...)		11930/K	
125	Nexus Euro 3	841213	(07/08)		11930/K	
125	Runner 125 dd/fx/sp		(01/...)		11928/K	

CINGHIE DI TRASMISSIONE

cm3	Modello	simile al	Anno Standard	Codice Kevlar	Codice Doppia	Codice
125	Runner FX/SP 2T	434812	(97/02)		11928/K	
125	Runner FX/SP 2T (oil pump belt)	431370	(97/02)		11928/K	
125	Runner VX/SC/Race/Euro 3 4T	841213	(01/08)		11930/K	
125	Typhoon 125	434812/431370	(95/00)		11928/K	
180	DNA 4T	827639/832623 840908	(01/...)			12988/D
180	DNA 4T 180	827639/832623 840908	(01/...)			12988/D
180	Runner FXR/SP 2T	484497	(97/02)		11928/K	
180	Runner FXR/SP 2T (oil pump belt)	431370	(97/02)		11928/K	
180	Runner VXR 4T 180	827639/832623 840908	(01/>)			12988/D

CINGHIE DI TRASMISSIONE

cm3	Modello	simile al	Anno	Codice Standard	Codice Kevlar	Codice Doppia
180	Tunner 180 dd/sp		(97/00)		11928/K	
180	VXR 180 4T	827639/832623 840908200				12988/D
	Runner 200		(02/...)		11928/K	
200	Runner VXR 4T 200	840908	(02/>)			12988/D
200	Runner VXR 4T/Race/Euro 3	840908	(02/08)			12988/D
200	VXR 200 4T	840908	(02/...)			12988/D
250	Nexus Euro 3/SP	843963	(06/08)			12990/D
500	Fuoco IE	832738	(07/08)			12991/D
500	Nexus/Euro 3/SP	832738	(03/08)			12991/D
800	GP	845010	(08/...)		11988/K	
50	Storm 50	286162/430728	(93/96)	11924		
50	Typhoon 50	430728	(00/...)	10996	10996/K	

ARI KITS PARAOLIO FORCELLA

cm3	Modello	Anno	Codice	simile	Note
50	Easy Moving	—————	ARI.075		
50	Rcr	2005	ARI.114		
50	Rcr	2005	ARI.115		Dust for ARI.114
50	Rcr 50	2005	ARI.114		
50	Rcr 50	2005	ARI.115		Dust for ARI.114
50	Runner 50 Pure Jet	2005	ARI.112	564236	
50	Runner 50 Racing Replica	2005	ARI.112	564236	
50	Runner Sp	2005	ARI.112	564236	
50	Stalker	2005	ARI.112	564236	
50	Storm	—————	ARI.076		
50	Typhoon	—————	ARI.076	272441	
50	Typhoon Benetton	—————	ARI.076	272441	
50	Typhoon Martini	—————	ARI.076	272441	

ARI KITS PARAOLIO FORCELLA

cm3	Modello	Anno	Codice	simile	Note
50	Typhoon Street	—————	ARI.076	272441	
80	Typhoon-Showa-	98->	ARI.076	272441	
125	Runner Fx	—————	ARI.113	564236	
125	Runner Sp	—————	ARI.113	564236	
125	Runner Vx 125	2005	ARI.051	598190	
125	Tg2	83-84	ARI.014		
125	Tg3	83-84	ARI.014		
125	Typhoon-Showa-	98->	ARI.076	272441	
180	Runner Fx	—————	ARI.113	564236	
180	Runner Sp	—————	ARI.113	564236	
200	Runner Vxr 200	2005	ARI.051	598190	
500	Nexus 500	2005	ARI.102	975702/599267	

<i>Articolo</i>	<i>Descrizione</i>	<i>Simile al Nr. Orig.</i>
00659	Manopola Leva Avviamento - Colore Grigio	15428
00687/B	Paio Manopole Ape P401/501/601	141925
01966	Soffietto Copripolvere Pompa Freni	76386
01967	Copripolvere Pompa Leva Freno 150 Cc.	
02964	Elemento Elastico Sul Supporto Centrale Modello 150 Cc.	3480
02988	Tampone Elastico Per Forcella Di Attacco Sella Al Telaio	
02992	Tampone Ammortizzatore Sede Cuscinetti Differenziale	
02993	Tampone Supporto Motore	
02994	Tampone Elastico Diam. 29x12,5x17,5	
03859	Tampone Di Centraggio Leva Messa In Moto Ape C	
03908/A	Guarnizione Diam.61 X 39 X 3	56912
03967	Tampone Molleggio Ruota Anteriore	
04904	Protezione Passaggio Cavo Alta Tensione Ape C	
04980	Guarnizione Esterna Freni C/4	
04980/A	Guarnizione Freni Idraulici	119330
04993	Soffietto Carburatore Mp/Car	133404
05901/A	(Esaurim) Boccola Leva Avv.350-400 Dal'65-67 500 Dal'66-67	76129
05921	Cuffia Semiassesse Mp/Car	198618
05971	Giunto Semiassesse Mp/Car	228302(EX113450)
06920	Soffietto Pompa Freni Idraulici 350-400-450-500-Mp	76386
06943	Cuffia Semiassesse 50 Cc. Dal '69 - 250 '70/74	119989
06969	Supporto Attacco Motore Mp-Mpv-Car Dal 78 - P2-P3 Ape 601	105976
07902	Soffietto Convogliatore Aria Calda	108827
08987/A	Raccordo Scatola Depuratore Ape P.602-P.703	220403
09969	Manicotto Flangiato Per Carburatore Tm/703	244787
11960	Flangia Carburatore Ape Poker	288676



08987/A



05921



09969



05971



06943



06969



★ 01966



★ 01967



★ 06920



★ 03967



★ 04904



★ 02992



★ 02964



★ 02988



★ 02993



★ 02994



★ 05901/A



★ 04980



★ 03908/A



00687/B

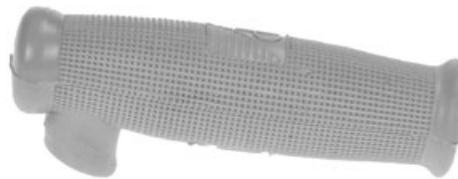

★ 00659



11960



★ 07902



★ 03859



04980/A



04993

TUBETTO BENZINA

Misura	Descrizione	Confezione	Codice
5,5 x 10	Nero	10 metri	03904/10
5,5 x 10	Verde Trasparente	10 metri	03904/10-V
5,5 x 10	Viola Doppio Strato Per Benzina Senza Piombo	10 metri	03904/10-S
6 x 13	Verde Trasparente	50 metri	01902-V
6 x 13	Nero	10 metri	01902/10
6 x 13	Verde Trasparente	10 metri	01902/10-V

SERIE PARAOLIO FRENO

Descrizione	Codice
Serie Paraolio Pompa Freni 150/C	Old Model 02854
Serie Paraolio Ceppi Freno 3 ^a Serie	Old Model 04877
Serie Paraolio Ceppi Freno C/4 '62-Ad-Ae-Aeo	Old Model 07876
Serie Paraolio Pompa Centrale Ad/1 175-Mp/Car	08869
Serie Paraolio Ceppi Freno Ruota Anteriore Mp Diam.20	Old Model 08894
Serie Paraolio Ceppi Freno Anteriore Mp Diam.22	08894/A
Serie Paraolio Pompa Freni Ape P 50 - Ape Tm P 50 - FI2	09857
Serie Paraolio Ceppi Freno 50 Cc.	09858
Serie Paraolio Ceppi Freno Cilindretti Post. Mp-Mpv-Mpr-Car	09891
Serie Paraolio Pompa Centrale Tm/602-Tm/703	11870
Serie Paraolio Ceppi Freno Ant. E Post. Tm P/602-Tm P/703	11871
Serie Guarnizioni Ceppi Freno Post. Ape 50 -Tm - P50/FI2	orig. 154797 11893

SERIE PARAOLIO MOTORE

Descrizione	Codice
175-Mp-Mpr-Mpn-Mpv-Car-P400-P601	08878
P 602 Tm-P 703 Tm	10895
P 601 Ls-Car Ls2 P2 Solo Motore	11858
P.501 - P.601 Ii Serie Dal 1985	Old Model 11886

PARAOLIO SINGOLI**APE 50**

Misura	Descrizione	simile al	Codice
SC 32 19 7	Per Albero Motore	S/8720 - 15579	P/089
SC 40 28 7	Per Semiassi	116205	P/155
SC 42 27 10	Per Mozzo Ruota Posteriore	118058	P/170
SC 42 32 7	Per Sospensione Anteriore	3/21460	P/174
SC 47 22,7 7	Per Albero Motore	S/8731	P/189

PARAOLIO SINGOLI**APE 400**

Misura	Descrizione	simile al	Codice
SC 28 17 7	Per Albero Motore	S/8720 - 15579	P/089
SC 45 24,9 6,5	Per Albero Motore	78002	P/178
SC 47 20 8	Per Ruota Anteriore	2/93343	P/186
SC 47 28 7	Per Cambio	S/7337	P/194
SC 52 32 5	Per Albero Motore	S/8733	P/220
SC 62 32 6	Per Albero Motore	S/127891- S/8734	P/257

APE MP - MPR - MPM - MPV - CAR - P400/601

Misura	Descrizione	simile al	Codice
SC 18 10 4	Per Albero Camma Ruttore	152351	P/006
SC 32 22 7	Per Semiassa	S/7276	P/096
SC 45 24,9 6,5	Per Albero Motore Lato Volano Esterno	78002	P/178
SC 47 35 7	Per Trasmissione	2/20359	P/201
TC 50 33 6	Per Crociera Trasmissione	S/17014	P/208
SC 52 32 5	Per Albero Motore Lato Volano Interno	77976	P/220
SC 62 32 6	Per Albero Motore Lato Frizione	2/27891-S/8726	P/257

APE CAR LD - P601 LS - P2

Misura	Descrizione	simile al	Codice
HSCRY 45 24,9 6,5/5,5	Per Albero Motore	145597	P/179
SC 52 32 5	Per Albero Motore Lato Volano Interno	77976	P/220
SC 62 32 6	Per Albero Motore Lato Frizione	2/27891-S/8726	P/257

<i>Articolo</i>	<i>Descrizione</i>	<i>Simile al Nr. Orig.</i>
01584	Coprileva Cambio Lungh.40 Foro Passante Diam.8	
01590	Coprileva Avviamento Yamaha	
01663/SSF	Paio Manopole	
01681/SSF	Paio Manopole	4FM2624000/4FM2624100
01694/SSF	Paio Manopole R1 - Majesty	
02519	Copripedale Passeggero	1202743300
02626/SSF	Paio Manopole Dal 2009	
07907	Paio Soffietti Dt 125	2A62319100
09913	Paio Soffietti DT 50 MX - Nero (Anni '80)	
09968	Manicotto Carburatore Yamaha Rd 250-350	2R9-13565-01
09990	Paio Soffietti Supertenera' Nero	
10954	Paio Soffietti Yamaha Scooter - MbK - Booster Fino Al 1994	



01590



01663/SSF



01681/SSF



01694/SSF



02626/SSF



02519



09968



10954



01584



09913



09990



07907

<i>Articolo</i>	<i>Descrizione</i>	<i>Simile al Nr. Orig.</i>
02502	Appoggiapiede Zundapp Ks 50	43314119
02516	Coprileva Cambio Mod. 1980	
06908	Soffietto Protez. Catena	51714154
06913	Soffietto Conico Forcella - KS50 - KS80 - GTS50 - Diam.33/45 - Lungh.220	51812100
06927	Manicotto Zundapp	26604139
06928	Manicotto Carburatore	
06929	Manicotto Carburatore	26704139/12
06930	Manicotto Carburatore	28304102
06937	Manicotto Carburatore	
08907	Manicotto Carburatore Cs	27804112
08908	Manicotto Carburatore Gts-Ks	28004106
08915	Soffietto Forcella Sprinter	44812106
08923	Manicotto Marmitta	44622107
08925	Cono Scatola Filtro	51710109
08926	Cono Scatola Filtro	52910137
08944	Tampone	51718109
08945	Boccola	52918107
08947	Manicotto Carburatore	27804136
08948	Manicotto Carburatore Diam.27/32 Sprinter	28004114
08950	Manicotto Diam.32/34 Hai 50 Cc.	44822118
08952	Manicotto Carburatore Diam.28 125 Cc.Ks	28504209
08957	Tassello Serbatoio	



06913



☆ 06908



☆ 08915



☆ 06927



☆ 06928



☆ 06929



☆ 06930



☆ 06937



☆ 08952



☆ 08948



☆ 08947



☆ 08908



☆ 08907



☆ 08926



☆ 08925



☆ 08957



☆ 02516



☆ 02502



☆ 08950



☆ 08923



☆ 08945



☆ 08944

<i>Articolo</i>	<i>Descrizione</i>	<i>Simile al Nr. Orig.</i>
00697	Paio Manopole Ciclomotore Diam. 22-24	SX 44417903 - DX 51017912
01597	Coprileva Cambio Lungh.54 Foro Cieco Diam.8	616225
01602	Paio Manopole Comando Magura Diam. 22-24 Mm	
01609/A	Paio Manopole Comando Magura Diam. 22-24 Mm	SX 53017107 - DX 53017915
01611	Paio Manopole Comando Magura Diam. 22-24 Mm - Moped	SX 52917113 - DX 52917902
03906	Boccola	44816105
03966	Tamponcino	26601217
04990	Calotta Forcella Diam 30	51712167
06902	Tendicavo Comando Gas Magura	
08921	Boccola Diam.20 X 11 X 11,6	43315112
08922	Boccola Parastrappi Diam.29 X 18 X 11,5 Per Mozzo Diam.150	51715112
08924	Tappo	51716239
08927	Tappo Ispezione	43214117
08932	Passacavo Grigio Scuro	43212120
08946	Tampone Pedale Cambio	26705130

MANOPOLE STANDARD

<i>Articolo</i>	<i>Descrizione</i>	<i>Simile al Nr. Orig.</i>
00623/24	Paio Manopole Ciclomotore Lungh. 100 Mm	
00623/24/GR	Paio Manopole Lung. 100 Mm - Grigio	
00693	Paio Manopole Diam.22-24 Gomma Nera Modello Doherty	
01602	Paio Manopole Gomma	
01617/A	Paio Manopole Anni 70-80 Colore Nero	
01617/A-P	Paio Manopole Anni 70-80 Colore Para	
01617/A-R	Paio Manopole Anni 70-80 Colore Rosso	
01623	Paio Manopole Asp Nero	



01609/A
☆ 01611



☆ 00697



☆ 01602



☆ 04990



☆ 06902



01597

MANOPOLE STANDARD



☆ 00623/24



☆ 00623/24/GR



01617/A
☆ 01617/A-P
01617/A-R



☆ 01602



☆ 00693



01623

<i>Articolo</i>	<i>Descrizione</i>	<i>Simile al Nr. Orig.</i>
00670/24	Manopola Industriale Per Tubo Diam. 24 - Lungh. Mm 125	
00670/27	Manopola Industriale Per Tubo Diam. 27 - Lungh. Mm 125	
00687/21	Manopola Industriale Per Tubo Diam. 21 Lungh. 125 - Colore Nero	
00687/22	Manopola Industriale Per Tubo Diam. 22 Lungh. 130 - Colore Nero	
00687/24	Manopola Industriale Per Tubo Diam. 24 Lungh. 130 - Colore Nero	
00687/27	Manopola Industriale Per Tubo Diam. 27 Lungh. 125 - Colore Nero	
00698/28	Manopola Industriale Per Tubo Diam.28 - Lungh. Mm 120 - Colore Nero	
00698/30	Manopola Industriale Per Tubo Diam.30 - Lungh. Mm 120 - Colore Nero	
00698/32	Manopola Industriale Per Tubo Diam.32 - Lungh. Mm 120 - Colore Nero	
01609/A	Paio Manopole Asp Magura Per Moto - Diam. 22-24	
01611	Paio Manopole Asp Magura Per Ciclomotore Diam. 22-24	
01626/22	Manopola Industriale Per Tubo Diam. 22 Lungh. 135 - Colore Nero	
01626/24	Manopola Industriale Per Tubo Diam. 24 Lungh. 135 - Colore Nero	
01635/24	Manopola Industriale Per Tubo Diam. 24 Lungh. 120 - Colore Nero	
01635/26	Manopola Industriale Per Tubo Diam. 26 Lungh. 120 - Colore Nero	
01635/28	Manopola Industriale Per Tubo Diam. 28 Lungh. 120 - Colore Nero	
01646	Paio Manopole Mountain Bike Per Tubo Diam. 22 - Lungh. Mm 122	
01649	Paio Manopole Mountain Bike Per Tubo Diam. 22 - Lungh. Mm 123	
01656	Paio Manopole Lamellari Nere Per Tubo Diam. 22 - Lungh. Mm 110 - Per Bicicletta	
01656/18	Paio Manopole Lamellari Nere Per Tubo Diam. 18 - Lungh. Mm 110	
01683/22	Manopola Diam.22 - Lungh. Mm 125	
01683/24	Manopola Diam.24 - Lungh. Mm 125	



☆ 01611



01609/A



01683/22
01683/24



01626/22
01626/24



00670/24
00670/27



00687/21
00687/22
00687/24
00687/27



01635/24
01635/26
01635/28



00698/28
00698/30
00698/32



01656
01656/18



01649
01646

<i>Articolo</i>	<i>Descrizione</i>	<i>Simile al Nr. Orig.</i>
00508	Copripedale Guidatore Lungh. Mm 120 Foro Cieco Diam.14	
00511	Copripedale Guidatore Lungh. Mm. 110 Foro Cieco Diam. 26	
00549	Copripedale Lungh. Mm. 125 Foro Cieco Diam. 15	
00571	Copripedale Guidatore Lungh. Mm. 125 Foro Cieco Diam. 18	
01517	Copripedale Guidatore Lungh.110 Foro Cieco Diam.12-14-16	
01543/A	Copripedale Guidatore Lungh.104 Foro Cieco Diam.14	
01571	Copripedale Guidatore Lungh.112 Mm. Foro Cieco Diam.12-14-16	
01572	Copripedale Guidatore Lungh.81 Foro Cieco Diam.17	
01580	Copripedale Guidatore Lungh.115 Foro Cieco Diam.12	
01580/A	Copripedale Guidatore Lungh.105 Foro Cieco Diam.12	
01591/B	Copripedale Guidatore Lungh.94 Foro Cieco Diam. 14	
01593	Copripedale Guidatore Lungh.110 Foro Cieco Diam.14	
02515	Copripedale Guidatore Foro Cieco Diam.16 Lungh.107	
02515/A	Copripedale Guidatore Foro Cieco Diam.18 Lungh.107	
02526/A	Copripedale Guidatore Foro Cieco Diam.14 Lungh.85	
02529	Copripedale Guidatore Foro Cieco Diam.21 Lungh. 100	
02540	Copripedale Guidatore Lungh.94 Foro Cieco Diam. 14	
02540/A	Copripedale Guidatore Lungh.94 Foro Cieco Diam. 16	



★ 00508



★ 00511



01543/A



★ 00571



★ 01517



★ 00549



★ 01571



01572



★ 01580/A



★ 01580



01591/B
02540
02540/A



01593



★ 02515
02515/A
02529



02526/A

<i>Articolo</i>	<i>Descrizione</i>	<i>Simile al Nr. Orig.</i>
00502	Copripedale Passeggero	
00510	Coprileva Cambio	
00554	Copripedale Passeggero	
00554/B	Copripedale Passeggero Foro Passante Diam. 17 Mm	
00556	Coprileva Cambio-Freno Diam. 12 L=79 Mm	
00557	Coprileva Avviamento Diam. Int. 13 - Lungh. 75 Mm	
00597	Coprileva Cambio	
00598	Coprileva Avviamento	
01507	Coprileva Avviamento Lungh.70 Foro Passante Diam.12	
01507/A	Coprileva Avviamento Lungh.70 Foro Passante Diam.14	
01507/B	Coprileva Avviamento Lungh.70 Foro Passante Diam.11	
01512	Coprileva Cambio Lungh.40 Foro Cieco Diam.9	
01514	Coprileva Cambio Foro Cieco Rettangolare 21x14 - Lungh.55	
01532	Coprileva Lungh.40 Foro Cieco Diam.10	
01535	Coprileva Cambio Lungh.46 Foro Passante Diam.10	
01535/A	Coprileva Cambio Lungh.46 Foro Passante Diam.13	
01567	Coprileva Avviamento Lungh.65 Foro Cieco Diam.12	
01570	Coprileva Avviamento Lungh.53 Foro Cieco Diam.14	
01596/A	Coprileva Avviamento Lungh.52 Foro Passante Diam.10	
02501	Coprileva Cambio Foro Passante Diam.7,5 Lungh.30	
02501/A	Coprileva Avviamento	
02513	Coprileva Foro Cieco Diam.12 Lungh.54	
02514	Coprileva Cambio Foro Passante Ovale 10 X 6 Lungh.44	
02517	Coprileva Foro Passante Diam.9,5 Lungh.70	



00502



★ 00554
00554/B



00557



02517



00556



01507
01507/A
01507/B



01535
01535/A



02514



00510



01567



★ 02513



01570



00598



01596/A



00597



01532



01512



02501/A



02501



01514

<i>Articolo</i>	<i>Descrizione</i>	<i>Simile al Nr. Orig.</i>
01961	Soffietto Forcella Diam.30/32 9 Spire Lungh.135	
01961/A	Soffietto Forcella Diam.27/33 Lungh.175	
01970	Soffietto Forcella Diam.22/28 8 Spire Lungh.1110	
02966	Soffietto Forcella Diam.23/35 8 Spire Lungh.145	
04905	Soffietto Forcella Diam.48/48 15 Spire Lungh.190	
04983	Soffietto Forcella Diam.50/55 23 Spire Lungh.230	
05954	Soffietto Forcella Diam.50/55 Lungh.215	
05955	Soffietto Forcella Diam.30/40 Lungh.150	
05956	Soffietto Forcella Diam.50/50 Lungh.150	



01961/A



☆ 01961



02966



☆ 01970



☆ 05954



☆ 04905



☆ 05956



04983



☆ 05955

<i>Articolo</i>	<i>Descrizione</i>	<i>Simile al Nr. Orig.</i>
06970	Paio Soffietti Diam. 31/51 Lungh. 340	
07901	Paio Soffietti Diam. 35/55 Lungh. 350	
08904	Soffietto Forcella Diam.35/58 Lungh.290	
09932	Paio Soffietti Diam. 40/57 Lungh. 355	

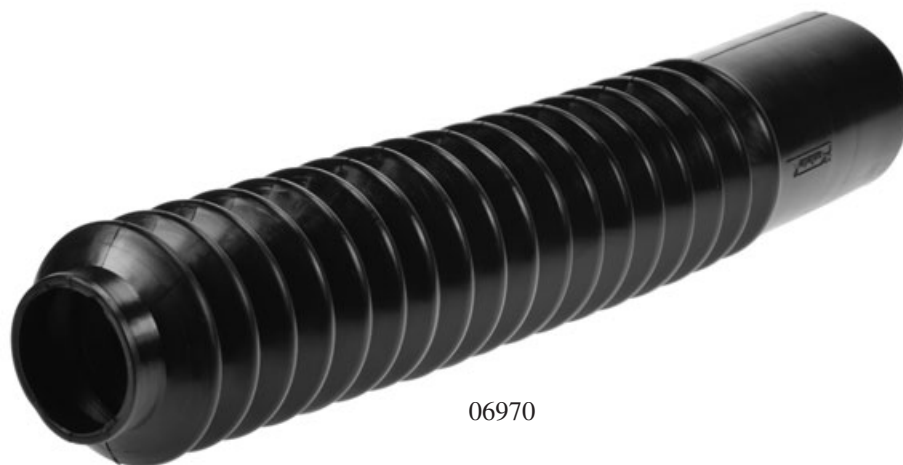

06970

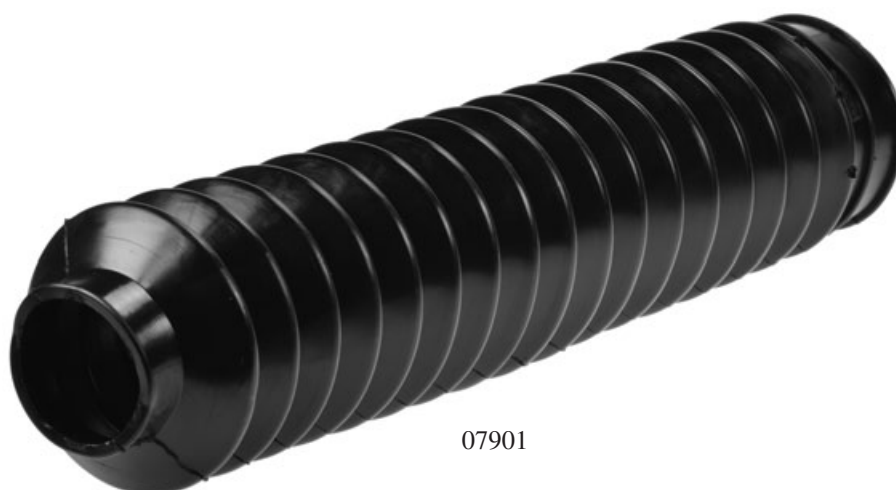

07901



08904

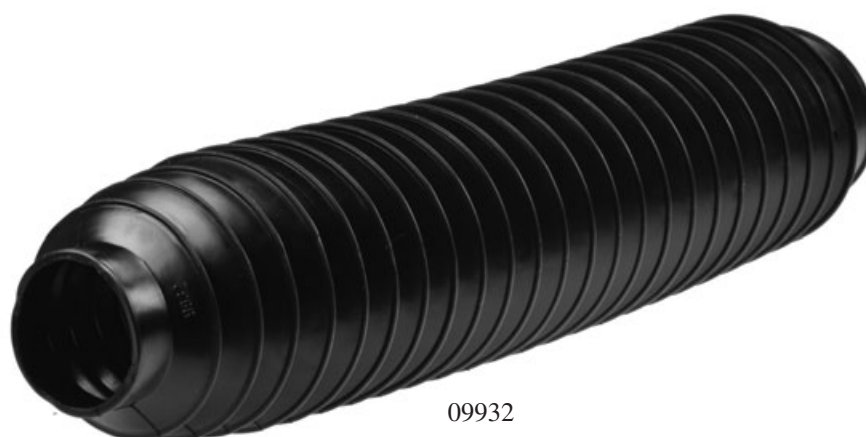

09932

<i>Articolo</i>	<i>Descrizione</i>	<i>Simile al Nr. Orig.</i>
07995	Paio Soffietti Diam. 38/58 Lungh. 350	
09942/A	Paio Soffietti Diam. 33/53 Lungh. 335	
09943	Paio Soffietti Diam. 38/58 Lungh. 360	
09950	Paio Soffietti Diam. 43/80 Lungh. 380	



09942/A



09943

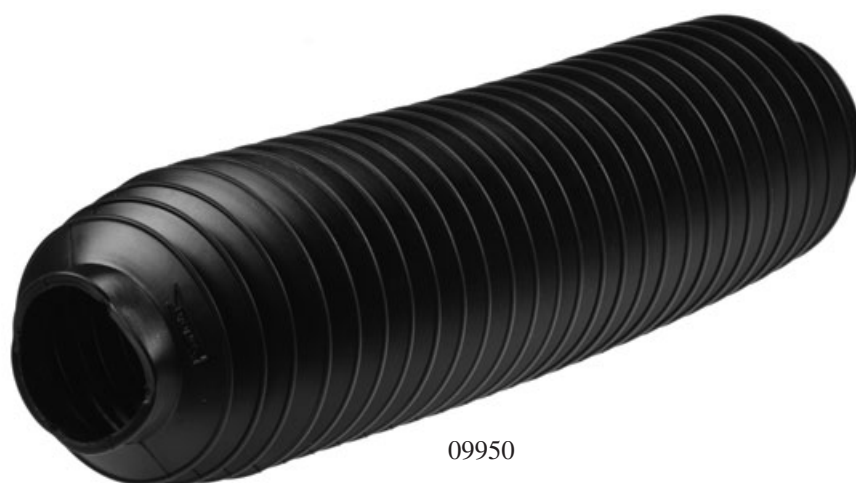

09950



07995

<i>Articolo</i>	<i>Descrizione</i>	<i>Simile al Nr. Orig.</i>
04914	Soffietto Forcella Diam.39/42 20 Spire Lungh.215	
04982	Soffietto Forcella Speedway Diam.22/26 5 Spire Lungh.160	
06962	Paio Soffietti Diam. 31/51 Lungh. 245	
06981	Soffietto Forcella Diam.27/41 Lungh.240 15 Spire	
09927	Paio Soffietti Diam. 29/45 Lungh. 215	
09941	Paio Soffietti Diam. 30/52 Lungh. 245	



09941



09927



06962



06981



04914



★ 04982

<i>Articolo</i>	<i>Descrizione</i>	<i>Simile al Nr. Orig.</i>
03988	Cinghietta Per Batteria Lungh.280	
05949	Elastico Per Serbatoio Lungh.250	
05949/A	Elastico Per Serbatoio Lungh.210	
05992	Cinghia Elastica Lungh.150	
06958	Anello Elastico Piccolo	
06958/A	Anello Elastico Grande	
06984	Cinghia Per Batteria Lungh.115	
06985	Cinghia Per Batteria Lungh. 110	
06986	Tirantino Lungh.140	
06987	Tirantino Con Occhielli Lungh.100	
08928	Tirante Serbatoio Lungh. 88	
08930	Tirante Serbatoio Lungh. 210	
09912	Tirantino Per Portaforo Tipo Acerbis	



03988



09912



05949



05949/A



05992



06984



06958/A



06958



08928



06986



06987



08930



06985

<i>Articolo</i>	<i>Descrizione</i>	<i>Simile al Nr. Orig.</i>
04999	Cappuccio Candela In Silicone Rosso Attacco Piccolo Diam. 3,9 Mm	
04999/A	Cappuccio Candela In Silicone Attacco Grande Diam. 6,3 Mm	
04999/P	Cappuccio Candela In Neoprene Attacco Grande Diam. 6,3 Mm	
09965	Cappuccio Candela Rosso In Silicone Attacco Per Nottolino Diam. 6,3 Mm	
09965/A	Cappuccio Candela Nero In Silicone Attacco Per Nottolino Diam. 6,3 Mm	
09965-A	Cappuccio Candela Blu In Silicone Attacco Per Nottolino Diam. 6,3 Mm	
04999/C	Cappuccio Candela In Silicone Attacco Piccolo Diam. 3,9 Mm	
04999/L	Cappuccio Candela In Silicone Attacco Piccolo Diam. 3,9 Mm	
12949	Cappuccio Candela In Gomma Epdm - Resistore Ceramico 5k Ohm - Attacco Grande Diam. 6,3 Mm	
12949/S	Cappuccio Candela In Silicone - Resistore Ceramico 5k Ohm - Attacco Grande Diam. 6,3 Mm	

GUIDA CATENA

<i>Articolo</i>	<i>Descrizione</i>	<i>Simile al Nr. Orig.</i>
06945	Guidacatena	
06945/A	Pattino Guidacatena	
10908	Tendicatena Trial	

SILENT BLOCK



<i>Tipo A</i>	<i>Ø Esterno</i>	<i>H. Gomma</i>	<i>Filetto</i>	<i>H.Filetto</i>
06963	30	20	MM8	13
06969	40	34	MM10	20
08986	25	20	MM6	12
09936	30	15	MM8	18
09937	25	12	MM8	18
10922	15	15	MM4	11
10924	20	15	MM6	14



GUIDA CATENA



06945



06945/A



10908

SILENT BLOCK



<i>Tipo B</i>	<i>Ø Esterno</i>	<i>H. Gomma</i>	<i>Filetto</i>	<i>H.Filetto</i>
06963/A	30	20	M8F8	12
08986/A	25	20	M8F8	12
09961	25	20	M8F8	12
10918	20	20	M8F6	13
10919	25	15	M6F6	12
10923	20	20	M6F6	12



00902/A



00902



00921



00922



00923/A



00923



00925



★ 07967



07938



07957/A

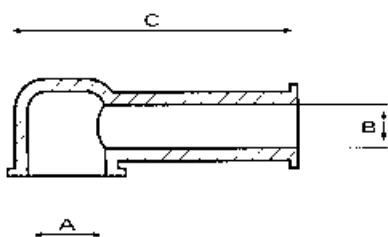

Articolo

A

B

C

00902	25	8	87
00902/A	27	7,5	77
00921	10	6	40
00922	15	7	44
00923	15	10	62
00923/A	17	8	65
00925	17	5	43
02986	18	8,5	56
07938	19	12	73
07957/A	17	7	45



☆ 00409/10



05951/A



☆ 05953



09972



05951



10938



08998

<i>Articolo</i>	<i>Descrizione</i>	<i>Simile al Nr. Orig.</i>
00409/10	Paio Ginocchiere Dx - Sx	
05951	Portatarga In Gomma Con Supporto Fanalino	
05951/A	Portatarga In Gomma	
05953	Soffietтино Protezione Carburatore Diam. 47 Mm.	
08998	Sostegno Bombolette Ammortizzatori	
09972	Tampone Appoggio Serbatoio Su Telaio Quadro Deltabox	
10938	Portatarga Ciclomotori Italiani	

<i>Articolo</i>	<i>Descrizione</i>	<i>Simile al Nr. Orig.</i>
00908	Cappuccio Diam. 6/14 - Lungh. 25	
00926	Passacavo Diam. Int. 3, Gola 6, Est. 9, Altezza Gola 1, Altezza Totale 7	
00928	Passacavo Diam. Int. 8, Gola 11, Est. 16, Altezza Gola 1, Altezza Totale 6,5	
00929	Passacavo Diam. Int. 8, Gola 12, Est. 16, Altezza Gola 1, Altezza Totale 8	
02910	Boccola Ammortizzatore Diam. 26x12 - Altezza 10	
03901	Boccola Ammortizzatore Diam. 33x12 - Altezza 13	
03901/B	Boccola Ammortizzatore Diam. 13x23 - Altezza 13	
03903	Boccola Ammortizzatore Diam. 22x10 - Altezza 9,5	
03989	Boccola Ammortizzatore Diam. 23x12 - Altezza 8	
04913/A	Soffietto Cavi Comandi - Base Diam. 16 mm.	
05933/A	Soffietto Cavi Comandi Diam. 6/9 - Lungh. 27	
06901	Raccordo Carburatore Scatola Filtro Diam. 40/57 - Lungh. 55 - CZ Anni 70/80	
06916	Cappuccio Diam. 5/12 - Lungh. 30 (Sachs)	
06960	Manicotto Carburatore Flangiato Sachs - Carburatore da 30 mm.	
06973	Paraspruzzi Parafango Anteriore	
07994	Paio Coprileva Freno-Frizione al Manubrio	
08967	Soffietto Copricavo Comandi KTM - Diam. 1/7 - Lungh. 57 (Base Cava)	5102092051
08967/A	Soffietto Copricavo Comandi KTM - Diam. 1/7 - Lungh. 57 (Base Piena)	121199000
09967	Soffietto Cavi Diam. 1/6 - Lungh. 75 (Peugeot)	
10927	Cappuccio Diam. 6/13 - Lungh. 20	
10933	Raccordo Cablaggi a 3 Vie - Diam. 10	
13906	Kimco - Tampone Battuta Cavalletto Centrale - Tutti i Modelli	



04913/A



06916



10927



00908



05933/A



10933



09967



08967
08967/A



13906



★ 02910



★ 03989



00926



00928



00929



★ 03903



03901/B



★ 03901



★ 06960



★ 07994



06973



★ 06901

<i>Articolo</i>	<i>Descrizione</i>	<i>Simile al Nr. Orig.</i>
00914/A	Manicotto Tubo Scarico Diam.32,5/34,5 Lungh.44	
00914/B	Manicotto Tubo Scarico Diam.34/36 Lungh.44	
00914/C	Manicotto Tubo Scarico Diam.23/24,5 Lungh.45	
00914/D	Manicotto Tubo Scarico Diam.19,5/22 Lungh.45	
05916	Manicotto Tubo Scarico Diam.26/28 Lungh.44	
05916/A	Manicotto Tubo Scarico Diam.29/31 Lungh.44	
05916/B	Manicotto Tubo Scarico Diam.40/41 Lungh.44	
05916/C	Manicotto Tubo Scarico Diam.23/27 Lungh.44	
06974	Manicotto Tubo Scarico Diam.17/19 Lungh.45	
06975	Manicotto Tubo Scarico Diam.21,5/24,5 Lungh.45	
08923	Manicotto Tubo Scarico Diam 22/26 Lungh. 49	
08923/A	Manicotto Tubo Scarico Diam.20/22 Lungh. 40	
08923/B	Manicotto Tubo Scarico Diam.25/27 Lungh.25	
08950	Manicotto Tubo Scarico Diam 32/34 Lungh. 45	
09966	Manicotto Tubo Scarico Diam.24/28 Lungh.44	
09992	Manicotto Tubo Scarico Diam 21/27 Lungh. 45	
10901	Tappo Tubo Scarico Per Lavaggio - Da Diam 19 A 38	
13904	Tappo Tubo Scarico Per Lavaggio - Da Diam 24 A 49	



00914/A



00914/B



00914/C



00914/D



05916



05916/A



05916/B



05916/C



06975



06974



★ 08923



★ 08950



09992



09966



08923/A



★ 08923/B



10901



13904

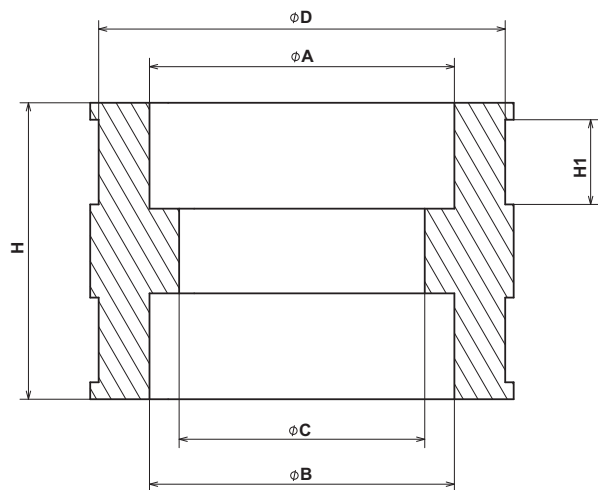

<i>Codice</i>	<i>A</i>	<i>B</i>	<i>C</i>	<i>D</i>	<i>H</i>	<i>H1</i>	<i>Materiale</i>	<i>Shore A</i>
★ 06930	24,5	24,5	21	34	30	10	NBR/PVC	65
★ 06937	36	34	29	48	35	10	NBR/PVC	65
06954	43	43	36	53	35	9	NBR/PVC	65

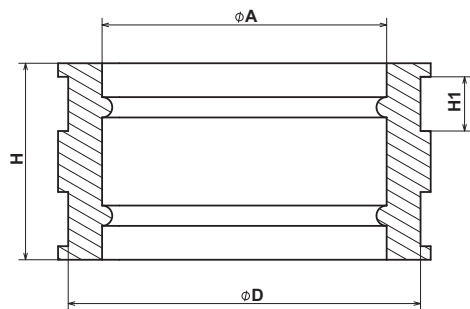

<i>Codice</i>	<i>A</i>	<i>B</i>	<i>C</i>	<i>D</i>	<i>H</i>	<i>H1</i>	<i>Materiale</i>	<i>Shore A</i>
06936	42	-	-	52	29	8	NBR/PVC	65

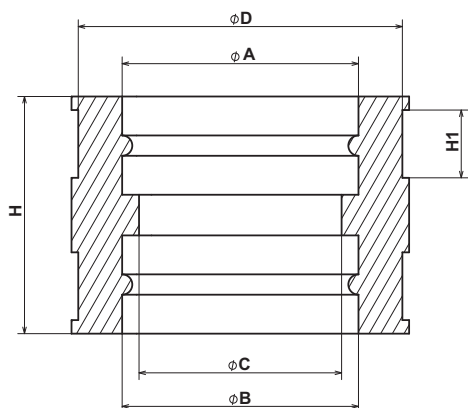

<i>Codice</i>	<i>A</i>	<i>B</i>	<i>C</i>	<i>D</i>	<i>H</i>	<i>H1</i>	<i>Materiale</i>	<i>Shore A</i>
06937/A	35	35	30	48	35	10	NBR/PVC	65
06954/A	44	44	36	55	33	12	NBR/PVC	65
06956	42	42	37	53	29	8	NBR/PVC	65
08906	49	49	41	59	35	13	NBR/PVC	65
08906/A	44	44	40	59	35	13	NBR/PVC	65
08906/B	44	44	34	59	35	13	NBR/PVC	65
08910	34	34	32	45	30	9	NBR/PVC	65
08911	34	30	27	45	30	9	NBR/PVC	65
★ 08952	33	33	28	48	40	10	NBR/PVC	65
08991	38	42	36	54	34	10	NBR/PVC	65
09998	34	34	28	44	34	12	NBR/PVC	65
09991	39	39	34	49	34	12	NBR/PVC	65
09999	42	42	39	55	34	12	NBR/PVC	65
10947	30	30	26	44	37	13	NBR/PVC	65
10948	26	23	21	44	37	13	NBR/PVC	65



12935

<i>Articolo</i>	<i>Descrizione</i>	<i>Simile al Nr. Orig.</i>
12935	Manicotto Carburatore Flangiato Dell'Orto PHBG 18-BS per Kart	

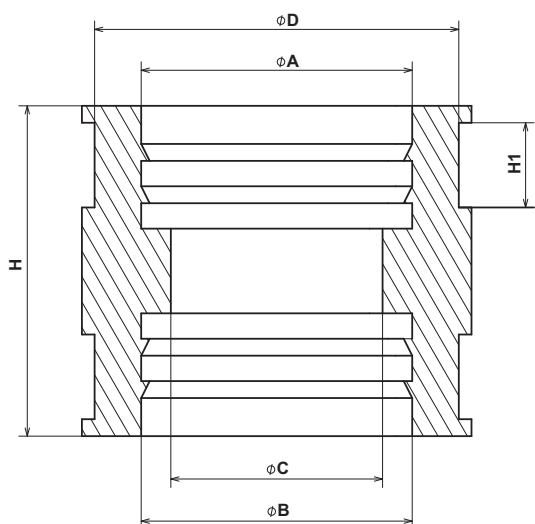

<i>Codice</i>	<i>A</i>	<i>B</i>	<i>C</i>	<i>D</i>	<i>H</i>	<i>H1</i>	<i>Materiale</i>	<i>Shore A</i>
06952	32	32	25	43	39	10	NBR/PVC	65
06952/A	32	32	27	42,5	39	10	NBR/PVC	65
06952/C	33	33	27,5	43,5	29	8	NBR/PVC	65
06955	43,5	43,5	30	59	38	10	NBR/PVC	65
06955/A	43,5	43,5	34	59	38	10	NBR/PVC	65
06955/B	43,5	43,5	36	59	38	10	NBR/PVC	65
06955/D	40	44	30	54	39	10	NBR/PVC	65



11903



11903/A

<i>Articolo</i>	<i>Descrizione</i>	<i>Simile al Nr. Orig.</i>
11903	Manicotto Speedway Diam. 34,5 per Motore GM e Jawa	
11903/A	Manicotto Speedway Diam. 37 per Motore GM e Jawa	

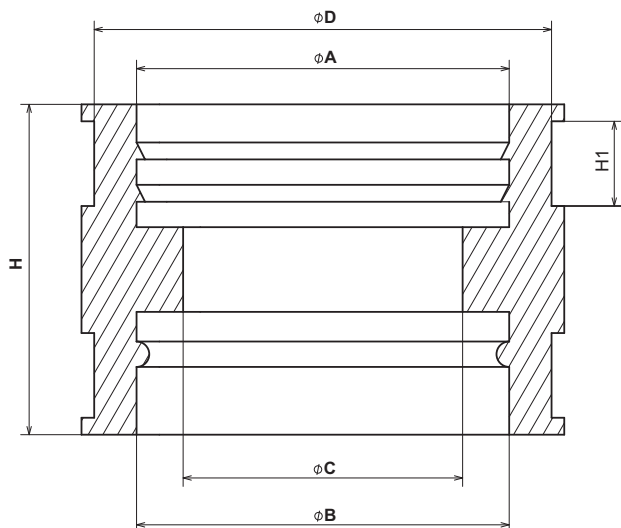

<i>Codice</i>	<i>A</i>	<i>B</i>	<i>C</i>	<i>D</i>	<i>H</i>	<i>H1</i>	<i>Materiale</i>	<i>Shore A</i>
★ 06953	44	40	33	54	39	10	NBR/PVC	65
★ 06953/A	44	40	20	54	39	10	NBR/PVC	65
★ 06953/B	44	40	33	54	39	10	NBR/PVC	65
06953/C	43	43	34	54	39	10	NBR/PVC	65
06955/C	43,5	43,5	40	59	39	10	NBR/PVC	65
08991/A	43	43	37	54	34	10	NBR/PVC	65

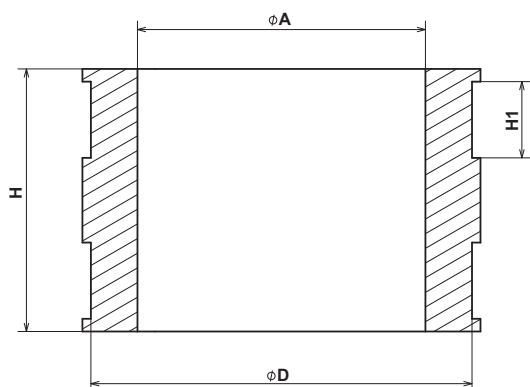

<i>Codice</i>	<i>A</i>	<i>B</i>	<i>C</i>	<i>D</i>	<i>H</i>	<i>H1</i>	<i>Materiale</i>	<i>Shore A</i>
08909	34	-	-	45	31	9	NBR/PVC	65



Descrizione degli anelli di tenuta paraolio

Gli anelli di tenuta paraolio rappresentano la migliore soluzione tecnica per quelle applicazioni che richiedono una perfetta tenuta di olii, grassi e simili intorno agli alberi rotanti.

Una notevole varietà di labbri di tenuta, parti metalliche strutturali e molle di tenuta è a disposizione dei Progettisti meccanici per meglio individuare il paraolio più adatto allo scopo specifico.

I materiali dei Labbri di tenuta, armature metalliche e molle.

Labbri di tenuta

- **Nitrile** Buna-N 70 è l'elastomero standard generalmente usato per i nostri paraolio ed è indicato per la maggior parte delle applicazioni motoristiche. Il labbro in Nitrile lavora in modo eccellente entro una gamma di temperature da -35°C a +125°C ed è resistente a molti olii e grassi minerali.
- **Silicone**, si tratta di un elastomero pregiato usato per le resistenze a temperature più elevate. Trova il suo impiego ideale tra -65°C e +190°C.
A causa del costo elevato si impiega in casi particolari.
- **Viton** è l'elastomero, fluorurato, di maggior pregio. Offre resistenze a temperature molto elevate in una gamma operativa da -40°C a +210°C.
Questo materiale resiste ottimamente ad olii, acidi ed altre sostanze che sono distruttive per il Nitrile od i Siliconi. È estremamente resistente alla abrasione ed ha performances eccezionali. Trova applicazione in quelle condizioni di criticità che altrimenti non avrebbero soluzione.

NITRILE, SILICONE, VITON sono i materiali utilizzati da ARIETE per i propri PARAOLIO

Armature metalliche strutturali e molle di tenuta

Se non specificato espressamente tutte le armature metalliche strutturali dei paraolio ARIETE sono ricavate da acciaio ad alto contenuto di carbonio. In applicazioni dove la corrosione potrebbe rappresentare un problema si utilizza acciaio inox ed il rivestimento elastomerico esterno protegge ulteriormente il paraolio.

I disegni delle seguenti sezioni rappresentano i paraolio comunemente usati nel settore motociclistico e motoristico.

ARIETE, gli speciali paraolio per moto & scooters

I nostri anelli di tenuta paraolio per alberi rotanti sono prodotti con una miscela elastomerica specificatamente studiata per la resistenza agli olii ed alle temperature che normalmente sono presenti nei motori.

Abbiamo in gamma circa 400 modelli di paraolio che vengono impiegati nel settore motociclistico.

L'alta qualità dei materiali utilizzati e l'ottimo grado di finitura, con rettifica dei labbri di tenuta fanno di questi paraolio un prodotto di alto livello tecnologico e di consolidato affidamento.

ARIETE, trade mark della Sandro Mentasti Srl di Varese, operante in Italia dal 1947, è sinonimo di alta qualità per accessori e ricambi, in gomma e materie plastiche, di motocicli e scooters.

Nel Febbraio 1998 il Sistema Qualità della Sandro Mentasti Srl ha ottenuto la Certificazione UNI EN ISO 9002 dal prestigioso Ente Certificatore scandinavo Det Norske Veritas, DNV.

Questo alto riconoscimento ufficiale ed internazionale rappresenta il punto di partenza del continuo miglioramento perseguito dalla nostra Azienda per il raggiungimento di una sempre maggior soddisfazione dei nostri Clienti.

ARIETE, tradizione della qualità

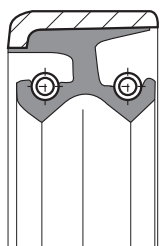

DB
2 labbri
lamiera esterna

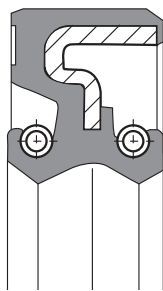

DC2Y
2 labbri

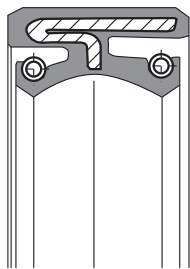

DCR2
2 labbri

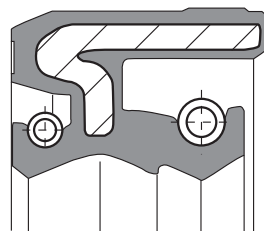

DCY
2 labbri

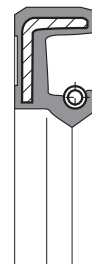

HSCJ
1 labbro

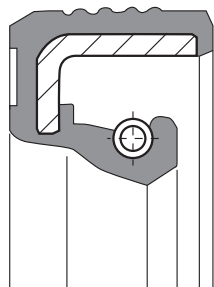

HSCR
1 labbro

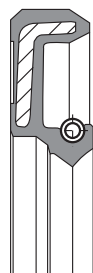

HSCRY
1 labbro

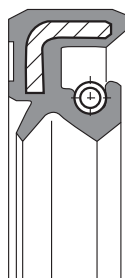

HTCL
1 labbro
+ parapolvere

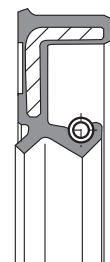

HTCYL
1 labbro
+ parapolvere



KC
senza molla
+ parapolvere

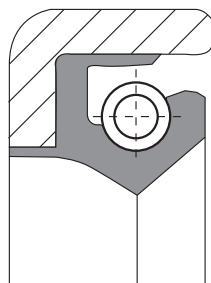

SB
1 labbro
lamiera esterna

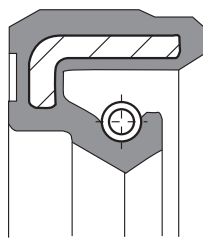

SC
1 labbro

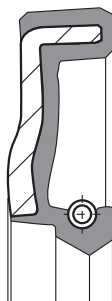

SCY
1 labbro

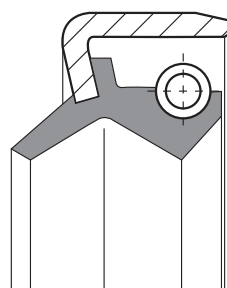

TBY
1 labbro
+ parapolvere
lamiera esterna

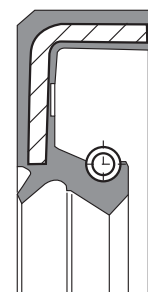

TC
1 labbro
+ parapolvere

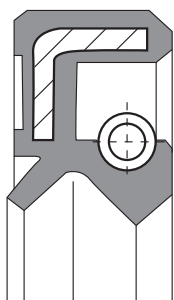

TCJ
1 labbro
+ parapolvere

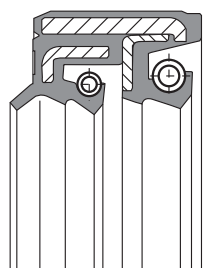

TCL4Y
2 labbri
+ parapolvere

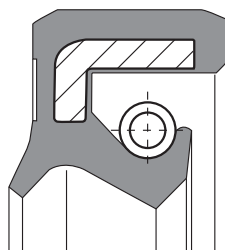

TCY
1 labbro
+ parapolvere

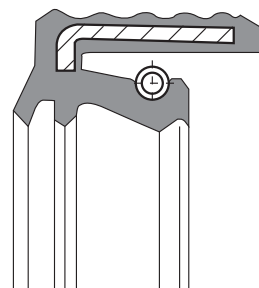

TG6
1 labbro
+ 2 parapolvere

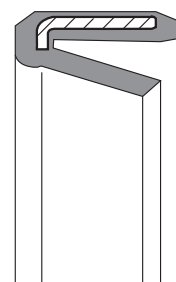

VC
senza molla

<i>Codice</i>	<i>Sezione</i>	<i>Misura</i>	<i>Materiale</i>
P/275	VC	11x6x4	NBR
P/294	SB	11X6X4	NBR
P/269	VB	12x8x3	NBR
P/001	VC	14,5x4,8x4	NBR
P/002	TC	14,5x6,5x7	NBR
P/309	SB	16 X 8 X 5	NBR
P/004	SC	16x6x7	NBR
P/005	SC	16x7x7	NBR
P/337	DCR2	16X8X10	NBR
P/361	TG6	16X8X10/11	NBR
P/296	SB	17X11X4	NBR
P/283	YC	17x12x2,5	NBR
P/006	SC	18x10x4	NBR
P/325	TC	18X10X4	NBR
P/343	DCY	18X10X5/8	NBR
P/276	VC5	18x12x11	NBR
P/007	VC	18x12x3	NBR
P/284	TC	18x12x5	NBR
P/292	TC	18X7X5	NBR
P/301	TC	18X9X7	NBR
P/009	SC	19x10x7	NBR
P/010	VC	19x12x3	NBR
P/291	SC	19X12X5	NBR
P/011	VC	19x13x3	NBR
P/008	SC	19x6x7	NBR
P/310	SB	20X12X5	NBR
P/311	TC	20X13X4	NBR
P/274	VB	20x16x2,5	NBR
P/307	SC	21X10X5	NBR
P/326	TC	21X10X5	NBR
P/312	TC	22X10X6	NBR
P/015	SC	22x10x8	NBR
P/016	SC	22x12x5	NBR
P/285	TC	22x12x5	NBR
P/017	SC	22x12x7	NBR
P/018	TC	22x12x7	NBR
P/019	SC	22X13X4	W/PTFE
P/020	SC	22x14x4	NBR
P/286	SCY	22x14x5	NBR
P/021	VC	22x14x7	NBR
P/022	VC	22x16x3	NBR
P/012	SC	22x6x7	NBR
P/014	SC	22x8x7	NBR

<i>Codice</i>	<i>Sezione</i>	<i>Misura</i>	<i>Materiale</i>
P/023	VC	23x17x3	NBR
P/024	TC	24X12X7	NBR
P/025	SC	24x13,7x5	NBR
P/313	SB	24X13X6	NBR
P/295	TC	24X14X7	NBR
P/027	SC	24x15x5	NBR
P/028	SC	24x15x7	NBR
P/029	TC	24x15x7	NBR
P/030	DB	24x15x7	NBR
P/031	VC	24x16x4	NBR
P/032	SC	24x16x5	NBR
P/034	DB	24x16x7	NBR
P/035	VC	24x18x4	NBR
P/358	TC	25X12X7	NBR
P/349	HSCR	25X12X8	NBR
P/037	TC	25x15x7	NBR
P/364	VB	25x17x3	NBR
P/038	SC	25x17x4	NBR
P/302	TC	25,5X15,6X7	SILICONE
P/277	SC	26X10X7	NBR
P/039	SC	26x12x8	NBR
P/040	SC	26x13x5	NBR
P/041	SC	26x15x7	NBR
P/042	TC	26x15x7	NBR
P/043	DB	26x15x7	NBR
P/278	TC	26X16X6	NBR
P/044	VC	26x20x4	NBR
P/320	SCAX	27X14X6	NBR
P/045	SC	27x15x7	NBR
P/299	TC	27X17X5	NBR
P/355	HTCL	27X17X5	NBR
P/354	TCJ	27X17X6	VITON
P/046	SC	27x19x6	NBR
P/047	SC	28x12x7	NBR
P/303	TC	28X12X7	NBR
P/049	TC	28x14x7	NBR
P/281	SC	28X15X5	NBR
P/050	SC	28x15x7	NBR
P/051	SC	28x16x7	NBR
P/279	TC	28x16x7	NBR
P/340	HTCL	28X17X5,5	NBR
P/052	SC	28x17x6	NBR
P/321	TC	28X17X6	NBR

<i>Codice</i>	<i>Sezione</i>	<i>Misura</i>	<i>Materiale</i>	<i>Codice</i>	<i>Sezione</i>	<i>Misura</i>	<i>Materiale</i>
P/053	SC	28x17x7	NBR	P/086	SC	32x17x7	NBR
P/054	TC	28x17x7	NBR	P/088	SC	32x18x8	NBR
P/055	DB	28x17x7	NBR	P/090	SC	32x19,8x5	NBR
P/359	TC	28X17X7/6	NBR	P/089	SC	32x19x7	NBR
P/056	TC	28x18x7	NBR	P/287	HTCL	32x20x6	NBR
P/057	VB	28x20x4	NBR	P/092	SC	32x20x7	NBR
P/058	SC	28x20x6	NBR	P/093	TC	32x20x7	NBR
P/293	TB	28 X 20 X 6	NBR	P/318	SB	32X20X7	NBR
P/059	TC	29x18x7	NBR	P/347	HSCR	32X20X7	SILICONE
P/060	SC	30x12x7	NBR	P/095	SC	32x22x5,5	NBR
P/061	SC	30x14x7	NBR	P/342	TC	32X22X6	NBR
P/067	SC	30x15x10	NBR	P/096	SC	32x22x7	NBR
P/335	TC	30X15X5	NBR	P/272	TC	32x22x7	NBR
P/062	SC	30x15x7	NBR	P/097	SC	33x25x4	NBR
P/063	TC	30x15x7	NBR	P/098	SC	34x20x7	NBR
P/064	DB	30x15x7	NBR	P/099	SC	34x24x5,5	NBR
P/065	SC	30x15x8	NBR	P/100	SC	35x11x10	NBR
P/066	SB	30x15x8	NBR	P/103	SC	35x15x10	NBR
P/069	SC	30x17x5	NBR	P/101	SC	35x15x7	NBR
P/304	TC	30X17X5	NBR	P/102	SC	35x15x8	NBR
P/070	TCY	30x17x6/6,5	NBR	P/110	SC	35x17x10	NBR
P/071	SC	30x17x7	NBR	P/104	SC	35x17x5	NBR
P/072	TC	30x17x7	NBR	P/105	SC	35x17x7	NBR
P/073	SB	30x17x7	NBR	P/106	TC	35x17x7	NBR
P/074	DB	30x17x7	NBR	P/107	DB	35x17x7	NBR
P/075	SC	30x18x7	NBR	P/108	SC	35x17x8	NBR
P/305	TCR	30X19X7	NBR	P/109	SB	35X17X8	NBR
P/327	TCRV	30X19X7	VITON	P/111	SC	35x18x8	NBR
P/076	SC	30x20x5	NBR	P/114	SC	35x20x10	NBR
P/077	SC	30x20x7	NBR	P/288	SC	35x20x5,5	NBR
P/297	TCJ	30X20X7	W/PTFE	P/360	TC	35X20X7	NBR
P/322	TC	30X20X7	NBR	P/113	TCY	35x20x7/7,5	NBR
P/078	DB	30x20x8	NBR	P/362	DC2Y	35X20X7	VITON
P/080	VC	30x24x7	NBR	P/118	SC	35x22x10	NBR
P/339	SC5	30/33.5X20X6	NBR	P/116	S	35x22x7	NBR
P/081	VCY	31x7x7,5/11	NBR	P/117	SC	35x22x8	NBR
P/298	TCJ	31X20X7	W/PTFE	P/119	TC	35x23x6	NBR
P/365	VB	31x25x2,5	NBR	P/120	HSCR	35x24x6	NBR
P/082	SC	31,5x13x3,5	NBR	P/121	SC	35x24x7	NBR
P/083	SC	32x15x5	NBR	P/124	TBY	35x25,7x7/9	NBR
P/084	SC	32x15x7	NBR	P/122	SC	35x25x7	NBR
P/087	SC	32x17x10	NBR	P/127	SC	35x26x10	NBR
P/085	SC	32x17x5	NBR				

<i>Codice</i>	<i>Sezione</i>	<i>Misura</i>	<i>Materiale</i>
P/126	TC	35x26x7	NBR
P/329	SB	35X26X7	NBR
P/280	TCY	36x24x7	NBR
P/300	TC	37X24X5	NBR
P/128	SC	37x25x5	NBR
P/353	TCJ	37X25X6	VITON
P/130	SC	37x27x7	NBR
P/131	TC	37x27x7	NBR
P/346	HTCYL	38X20X7	NBR
P/290	TC	38X25X7	NBR
P/315	TCJ	38X25X7	W/PTFE
P/132	SC	38x28x7	NBR
P/133	TC	38x28x7	NBR
P/316	TCJ	38X28X7	VITON
P/136	SC	39/34x22x5,5	NBR
P/341	KC	39X33X4	NBR
P/317	TCJ	40 X 25 X 7	W/PTFE
P/138	SC	40x17x6	NBR
P/139	SC	40x17x7	NBR
P/140	TCY	40x17x7/7,7	NBR
P/141	SC	40x17x8,5	NBR
P/145	SC	40x20x10	NBR
P/143	DC	40x20x7	NBR
P/144	DB	40x20x8/02	NBR
P/146	SC	40x22x7	NBR
P/334	HSCJ	40X22X7 LEFT	W/PTFE
P/147	SC	40x23x10	NBR
P/270	HSCRY	40X24,9X6,5	VITON
P/148	TC	40x24x7	NBR
P/154	DC	40x25x12	NBR
P/324	SCB	40X25X3	NBR
P/149	TC	40x25x6	NBR
P/323	HTCL	40X25X6	NBR
P/150	SC	40x25x7	NBR
P/151	TC	40x25x7	NBR
P/152	TBY	40x25x7	NBR
P/153	TCY	40x25x9/7	NBR
P/338	SCR	40X26,5X9	NBR
P/352	TC	40X27X6	NBR
P/156	TC	40x28x7	NBR
P/157	SC	40x30x7	NBR

<i>Codice</i>	<i>Sezione</i>	<i>Misura</i>	<i>Materiale</i>
P/158	TCYSC	40x30x7/9	NBR
P/160	SC	41x29x5	NBR
P/333	HTCY	42/43X20X8,9	NBR
P/161	SC	42x15x10	NBR
P/308	SB	42X20X10	NBR
P/162	SC	42x20x7	NBR
P/163	SB	42x20x7/02	NBR
P/330	TCBYR	42X20X7/9	W/PTFE
P/165	SC	42x22x10	NBR
P/164	SC	42x22x7	NBR
P/166	SC	42x25x6	NBR
P/167	TC	42x25x8	NBR
P/168	SC	42x25x8,5	NBR
P/336	TGJ	42X26X7	W/PTFE
P/170	SC	42x27x10	NBR
P/171	SC	42x28x7	NBR
P/172	SC	42x30x7	NBR
P/173	HSC	42x30x8	NBR
P/175	TCY	42x32x7/9	NBR
P/351	KC	43X24X6	NBR
P/282	SCY/5	44x32x8	NBR
P/178	SC	45x24,9x6,5	NBR
P/179	HSCRY	45X24,9X6,5/5,5	NBR
P/289	TC	45x25x7	NBR
P/314	SC	45X32X5	NBR
P/181	SC	45x32x6	NBR
P/271	TC	45x32x7	NBR
P/319	TC	46,43X31,75X9,5	NBR
P/183	SC	46x34x10	NBR
P/189	SCY	47 X 22,7 X 7/7,5	NBR
P/344	TBR	47,63X33,34X11,1	XNBR
P/345	TBR	47,63X34,13X11,1	XNBR
P/187	SC	47x20x10	NBR
P/184	SC	47x20x7	NBR
P/186	SC	47x20x8	NBR
P/188	SC	47x22x10	NBR
P/191	SC	47x25x10	NBR
P/192	SC	47x27x6	NBR
P/194	SC	47x28x7	NBR
P/348	HSCR	47X28X7	NBR
P/198	SC	47x30x10	NBR
P/195	SC	47x30x6	NBR

<i>Codice</i>	<i>Sezione</i>	<i>Misura</i>	<i>Materiale</i>	<i>Codice</i>	<i>Sezione</i>	<i>Misura</i>	<i>Materiale</i>
P/197	TC	47x30x7	NBR	P/248	SC	60x45x7	NBR
P/200	SC	47X32X12	VITON	P/252	TB5	61/50x33x6	NBR
P/199	SC	47x32x7	NBR	P/253	SC5	61/57X32X6	NBR
P/201	SC	47x35x7	NBR	P/257	SCY	62 X 32 X 6/7	NBR
P/202	TCY	47x35x7/9	NBR	P/256	SBY	62,5X31X4,3/5,8	NBR
P/328	SB	47X40X4	NBR	P/251	SC	62x20x6,5	NBR
P/204	TCL4Y	48X35X13,2/15	NBR	P/255	SCY	62x25x7/8	NBR
P/206	SC	50x25x10	NBR	P/259	SC	62x32x8	NBR
P/207	TC	50x30x10	NBR	P/273	SCY	62x34x6	NBR
P/208	TC	50x33x6	NBR	P/260	SC	62x37x8	NBR
P/210	SC	50x36x7	NBR	P/261	SC	62x45x10	NBR
P/211	SC	50x38x7	NBR	P/262	TC	65x45x10	NBR
P/212	TCY	50x38x7/9	NBR	P/263	SC	65x50x8	NBR
P/214	SC	52x20x10	NBR	P/264	SC	68x53x10	NBR
P/217	SC	52x25x10	NBR	P/356	SC	70X40X7,5	NBR
P/215	TC	52x25x7	NBR	P/357	SC	85X65X10,5	NBR
P/363	DC	52X25X8	NBR	P/266	SC	85x70x8	NBR
P/216	SC	52X25X9/01	NBR	P/267	SC	90x75x8	NBR
P/218	SC	52x30x10	NBR	P/268	SC	100 X 80 X 10	NBR
P/219	SC	52x31x7	NBR	P/350	HSCL	100X78X10	SILICONE
P/220	SC	52x32x5	NBR				
P/221	SC	52x32x7	NBR				
P/222	DB	52x32x7/9	NBR				
P/224	SC	52x33x6	NBR				
P/225	SC	52x34x10	NBR				
P/226	SC	52x35x10	NBR				
P/228	SC	52x38x10	NBR				
P/232	TC4	54x43x11	XNBR				
P/240	SC	55,5x38x9	NBR				
P/234	TC	55x30x10	NBR				
P/233	SC	55x30x7	NBR				
P/235	TC	55x35x9	NBR				
P/237	TC	55x40x7	NBR				
P/238	TC4Y	55x41,7x8	NBR				
P/241	SC	56x40x8	NBR				
P/242	SC	56x42x7	NBR				
P/243	DB	58x45x7	NBR				
P/244	SB5Y	60/40X20X6	NBR				
		TACCA QUADRA					
P/245	TB5	60/40X20X6	NBR				
		TACCA TONDA					
P/246	SC	60x40x10	NBR				
P/247	SC	60x42x10	NBR				

KITS Paraolio

Gli anelli di tenuta per alberi rotanti sono prodotti con una miscela di gomma resistente agli olii ed alle alte temperature. L'Ariete propone dei kits paraolio motore selezionati per ogni tipo di moto o scooter in circolazione.

L'alta qualità dei materiali impiegati e la "rettifica" di ogni anello eseguita con una apposita macchina a controllo sono alla base del successo di questa linea di prodotti stimati ed apprezzati dai Meccanici più esperti ed esigenti.



Old	Codice	Marca	Anno	Modello	Applicazione
☆	04887	AERMACCHI		125 CC. 2T	MOTORE E CAMBIO
☆	08861	AERMACCHI		175-250 CC.	MOTORE
☆	02854	APE		150/C	POMPA FRENI
☆	04877	APE		3ª SERIE	CEPPI FRENO
☆	07876	APE		C/4 '62-AD-AE-AEO	CEPPI FRENO
	08869	APE		AD/1 175-MP/CAR	POMPA CENTRALE
	08878	APE		175-MP-MPR-MPN-MPV-CAR-P400-P601	MOTORE
☆	08894	APE		MP DIAM.20	CEPPI FRENO RUOTA ANT.
	08894/A	APE		MP DIAM.22	CEPPI FRENO ANTERIORE
	09857	APE		APE P 50 - APE TM P 50 - FL2	POMPA FRENI
	09858	APE		50 CC.	CEPPI FRENO
	09891	APE		MP-MPV-MPR-CAR	FRENO CILINDRETTI POST.
	11870	APE		TM/602-TM/703	POMPA CENTRALE
	11871	APE		TM P/602-TM P/703	CEPPI FRENO ANT. E POST.
☆	11886	APE		P.501 - P.601 II SERIE DAL 1985	MOTORE
	11893	APE		APE 50 -TM - P50/FL2	CEPPI FRENO POST.
	11862	APRILIA		125 ETX '84 - ROTAX 126 LC	MOTORE
	11863	APRILIA		125 TUAREG 2ª SERIE '85/87 LC RAVE MISC	MOTORE
	11864	APRILIA		125 TUAREG RALLY '84/87	MOTORE
	11879	APRILIA		125 SINTESI	MOTORE
	11895	APRILIA	94-99	AMICO YOUNGER - BUSINESS - CLUB	MOTORE
	11896	APRILIA	95-98	SCARABEO 50	MOTORE
	11896	APRILIA	99	SCARABEO BRIGHT 50 - CLASSIC - DE LUXE	MOTORE
	11896	APRILIA	> 97	SR 50 WWW	MOTORE
	11896	APRILIA	97 >	SR 50 WWW	MOTORE
	12853	APRILIA	99	AREA 51	MOTORE
	12853	APRILIA	95-98	GULLIVER	MOTORE
	12853	APRILIA	96-99	GULLIVER LC	MOTORE
	12853	APRILIA	99	MC GULLIVER LC	MOTORE
	12853	APRILIA	97-99	RALLY 50 LC - 2FD	MOTORE
	12853	APRILIA	98-99	SONIC - GP LC - SPICE	MOTORE
	12853	APRILIA	94-98	SR 50 LC	MOTORE
	12853	APRILIA	99	SR 50 RACING ROSSI FD TETSUYA FD - STEALTH FD	MOTORE
	12853	APRILIA	> 97	SR NETSCAPER LC	MOTORE
	12853	APRILIA	97 >	SR NETSCAPER LC	MOTORE
☆	09868	ATALA		CALIFFO 119	MOTORE
	12850	ATALA	95-99	HACKER AT 12 50 - LC - RACING 50	MOTORE
	11852	ATALA-RIZZATO		22 CON PEDALIERA-CALIFFONE	MOTORE
☆	05867	BENELLI		48 CC. 3 MARCE	MOTORE
☆	07862	BENELLI		LEONCINO 125 CC. MOD. 1953/54	MOTORE
☆	07863	BENELLI		125 CC. MOD.1955/57	MOTORE
☆	08875	BENELLI		49 CC. 4 MARCE	MOTORE
☆	08875/A	BENELLI		3VP-3VK (DAL 1981)	MOTORE
☆	08884	BENELLI		GENTLEMAN / FAK 48	MOTORE

Old Codice	Marca	Anno	Modello	Applicazione
☆ 09861	BENELLI		MOTORELLA	MOTORE
☆ 09894	BENELLI		48 CC. 5 MARCE	MOTORE
☆ 10889	BENELLI		3 VKN	MOTORE
☆ 09856	BETA		48 CC. 4/5 MARCE	MOTORE
11896	BETA	94-99	TEMPO 13/16"	MOTORE
10888	BMW		TUTTI I MODELLI FINO AL 1980	MOTORE
☆ 09890	CAGIVA		350 GTS TV FINO AL 1971	MOTORE
☆ 10890	CAGIVA		175 - 250 2T	MOTORE
☆ 10891	CAGIVA		250 MXR - RX CROSS	MOTORE
☆ 10892	CAGIVA		125 SS - SST - SXT - ALETTA - LOW RIDER	MOTORE
10898	CAGIVA		125 WSXT-ALETTA ROSSA-ELEFANT-A.ORO	MOTORE
11887	CAGIVA		FRECCIA C9/10/12-125 TAMANACO-CRUISER	MOTORE
☆ 01889	CAPRIOLO		75 CC. PREMODIFICA	MOTORE
☆ 03871	CAPRIOLO		75 CC. POST-MODIFICA	MOTORE
12858	DERBI		DERBI SENDA R - BULTACO LOBITO - ASTRO	MOTORE
☆ 04889	DUCATI		125-175 CC.	FORCELLA
☆ 05861	DUCATI		DUCATI 100-125-175 MONOALBERO	MOTORE
☆ 09882	DUCATI		250-350-450 SCRAMBLER	MOTORE
☆ 08873	FRANCO MORINI		4 MP/S 4 MARCE 48	MOTORE
☆ 08889	FRANCO MORINI		GYROMATIC	MOTORE
10862	FRANCO MORINI		GS - SA RAFFREDDATO AD ACQUA	MOTORE
11885	FRANCO MORINI		MOTORE G 30-G 304	MOTORE
12850	FRANCO MORINI		MOTORE AH 50 L	MOTORE
☆ 02884	GARELLI		MOSQUITO 38/B 2°SERIE	MOTORE
☆ 08895	GARELLI		M EUREKA-KATIA	MOTORE
☆ 09886	GARELLI		FLEX Matic - GULP	MOTORE
☆ 10852	GARELLI		EUREKA - KATIA M - CHIC - NOI	MOTORE
☆ 10855	GARELLI		5V-E CROSS-CICLONE	MOTORE
☆ 10893	GARELLI		VIP 1 - 2 - 3 - 4	MOTORE
11898	GARELLI		GARELLI SUPER CICLONE - TEAM - TIGER	MOTORE
02857	GILERA		98-124-150 CC. 5V SPECIAL	FORCELLA
☆ 04891	GILERA		150-175 CC.	FORCELLA
05851	GILERA		B300 BICILINDRICA DAL 1953/1969	FORCELLA
☆ 05886	GILERA		98-124 GIUBILEO	MOTORE
☆ 07860	GILERA		GIUBILEO 175-202 CC.	FORCELLA
☆ 09888	GILERA		50 5V TRIAL	MOTORE
09889	GILERA		98-124 CC.	MOTORE
☆ 10899	GILERA		125 RV-RX-ARIZONA-200 RX	MOTORE
☆ 11875	GILERA		125 KK-KZ-TOP RALLY-SP01	MOTORE
11891	GILERA		STORM	MOTORE
11891	GILERA	94-97	TYPHOON	MOTORE
11891	GILERA	99	TYPHOON X	MOTORE
11891	GILERA	< 97	TYPHOON BENETTON - MARTINI - STREET	MOTORE

Old Codice	Marca	Anno	Modello	Applicazione
11891	GILERA	95-97	ZIP EASY MOVING 50	MOTORE
12855	GILERA	99	TYPHOON X 125	MOTORE
12855	GILERA	95-98	TYPHOON 125 FORCELLA SHOWA	MOTORE
☆ 01870	GUZZI		65 CC.	MOTORE
☆ 01870/A	GUZZI		CARDELLINO 73 CC.	MOTORE
☆ 02882	GUZZI		GALLETTO 192 CC.	MOTORE
☆ 03861	GUZZI		ERCOLE 1 TIPO	CEPPI FRENO
☆ 03863	GUZZI		ERCOLINO	CEPPI FRENO
☆ 03864	GUZZI		250-500 CC.	FORCELLA
☆ 05883	GUZZI		ERCOLE ULTIMO TIPO	POMPA FRENO
☆ 05884	GUZZI		ERCOLINO ULTIMO TIPO	POMPA FRENO
☆ 05885	GUZZI		ERCOLE ULTIMO TIPO	CEPPI FRENO
☆ 05889	GUZZI		LODOLA 175 CC SPORT	MOTORE
☆ 07857	GUZZI		ZIGOLO 110 CC.	FORCELLA TELESCOPICA
☆ 07868	GUZZI		STORNELLO 125 CC.	MOTORE
☆ 07868/S	GUZZI		STORNELLO 125 CC. - SILICONE	MOTORE
☆ 07869	GUZZI		STORNELLO 125 SPORT - 160 CC.	MOTORE
☆ 07869/A	GUZZI		STORNELLO 160 CC. 5 MARCE	MOTORE
☆ 07869/AS	GUZZI		STORNELLO 160 CC. - SILICONE	MOTORE
☆ 07869/S	GUZZI		STORNELLO SPORT 125/160 CC. - SILICONE	MOTORE
☆ 08877	GUZZI		DINGO-DINGO CROSS	MOTORE
☆ 08887	GUZZI		ERCOLE	MOTORE
☆ 09851	GUZZI		V7	FORCELLA
☆ 09870	GUZZI		NUOVO FALCONE	FORCELLA
☆ 09878	GUZZI		V7 SPECIAL	MOTORE
☆ 09879	GUZZI		V7 SPECIAL	CAMBIO
☆ 09880	GUZZI		V7 SPECIAL	TRASMISSIONE
09896	GUZZI		NUOVO FALCONE MILITARE	MOTORE
10869	GUZZI		850 T-T3-LE MANS-1000	MOTORE E CAMBIO
11869	GUZZI		V35-V50-V65-V75-V35 IMOLA 2 SERIE	MOTORE
11861	HONDA		125 MTX-NS F	MOTORE
11868	GUZZI		V35 - V50 1° SERIE - SOLO MOTORE	MOTORE E CAMBIO
11873	HONDA		XL 600 R	MOTORE
11874	HONDA		XL 600 LMN-LMF-RM/G	MOTORE
11880	HONDA		NSR 125 F/R	MOTORE
11882	HONDA	> 96	SH 50	MOTORE
11882	HONDA	94-99	SH 50 FIFTY	MOTORE
11899	HONDA	95-99	BALI	MOTORE
12857	HONDA	96 >	SH 50 NEW - SKY 50 - SH 100	MOTORE
12850	ITALJET	94-99	FORMULA 50 - LC - WILLIAMS	MOTORE
12850	ITALJET		SPORT GT	MOTORE
12850	ITALJET	97-99	TORPEDO	MOTORE
12850	ITALJET	94-99	VELOCIFERO	MOTORE
12850	ITALJET	99	VELOCIFERO 10"	MOTORE

Old Codice	Marca	Anno	Modello	Applicazione
☆ 06879	LAMBRETTA		LAMBRO FLI 2ª SERIE 450-550N-550V	POMPA FRENO
☆ 06880	LAMBRETTA		LI	MOTORE E RUOTA POST.
☆ 07898	LAMBRETTA		LI 125-150 SPECIAL 2%	MOTORE E RUOTE
☆ 08871	LAMBRETTA		JUNIOR 50-100-125 CC.	MOTORE
08893	LAMBRETTA		LI 125-150 3ª SERIE	MOTORE
09869	LAMBRETTA		LAMBRO 450-550-550 V	CEPPI FRENO
11896	MALAGUTI	94-99	CENTRO SL 50	MOTORE
11896	MALAGUTI	99	CENTRO SL 50 M	MOTORE
11896	MALAGUTI	94-99	F 10 JET LINE 50 - F 10 TIGERS 50	MOTORE
11896	MALAGUTI	94-99	F 12 PHANTOM 50	MOTORE
11896/AE	MALAGUTI		MOTORE (PREZZO ECONOMICO)	MOTORE
12850	MALAGUTI	95-99	CROSSER 50	MOTORE
12850	MALAGUTI	95-99	CROSSER 50 METALLIZZATO	MOTORE
12853	MALAGUTI	95-99	F 12 PHANTOM 50 LC	MOTORE
12853	MALAGUTI	95-99	F 12 PHANTOM 50 LC METALLIZZATO	MOTORE
12853	MALAGUTI	99	F 12 PHANTOM 50 LC 2 FD	MOTORE
12853	MALAGUTI	97-98	F 15 FIREFOX 50 LC	MOTORE
12853	MALAGUTI	97-98	F 15 FIREFOX 50 LC METALLIZZATO	MOTORE
11895	MBK	95-99	BOOSTER NEXT GENERATION	MOTORE
11895	MBK	94-97	BOOSTER R 50	MOTORE
11895	MBK	96-99	BOOSTER ROAD SPRINT - ROCKET - TRAK	MOTORE
11895	MBK		SORRISO	MOTORE
11896	MBK	94-99	EVOLIS 50	MOTORE
11896	MBK	95-97	FIZZ 50	MOTORE
11896	MBK		FORTE	MOTORE
08874	MINARELLI		P4 4 MARCE	MOTORE
08874/A	MINARELLI		RV 4 RAFFREDDATO AD ACQUA	MOTORE
08874/LG	MINARELLI		P4 4 MARCE (LAMIERA ESTERNA)	MOTORE
09850	MINARELLI		MOTORE V1	MOTORE
09871	MINARELLI		MOTORE P6	MOTORE
09871/A	MINARELLI		MOTORE P6 4 MARCE MODIFICATO	MOTORE
11895	MINARELLI		MOTORE MBK-BOOSTER-ZUMA SCARABEO-AMICO-BWS	MOTORE
11895/AE	MINARELLI		MOTORE (PREZZO ECONOMICO)	MOTORE
11897	MINARELLI		MOTORE 345	MOTORE
11897/A	MINARELLI		MOTORE AM6	MOTORE
12853	MINARELLI		MOTORI RAFFREDDATI A LIQUIDO	MOTORE
12859	MINARELLI		SCOOTER 50 CC (SOLO 2 PEZZI)	ALBERO MOTORE
☆ 03897	MORINI		175 CC.	MOTORE
☆ 05893	MORINI		SBARAZZINO	FORCELLA
☆ 05894	MORINI		SBARAZZINO 98 CC. CORSARO 125 CC.	MOTORE
☆ 05894/A	MORINI		CORSARO VELOCE 150 CC.	MOTORE
☆ 06881	MORINI		CORSARO MOD.1960	MOTORE
☆ 08870	MORINI		CORSARINO	MOTORE

Old Codice	Marca	Anno	Modello	Applicazione
☆ 07859	MOTOM		48 CC. MOD. 51 JUNIOR 1960/1962	MOTORE
☆ 01897	MV		CST CS CGS	GUARNIZIONI MOTORE
11885	MOTOVESPA		VESPINO ESPANA	GUARNIZIONI MOTORE
11882	PEUGEOT		METROPOLIS	MOTORE
11884	PEUGEOT		ST - RAPIDO	MOTORE
11894	PEUGEOT		BUXY	MOTORE
11894	PEUGEOT		BUXY RS	MOTORE
11894	PEUGEOT	> 96	SPEEDAKE	MOTORE
11894	PEUGEOT		SV 50 EXECUTIVE	MOTORE
11894	PEUGEOT	94-98	SV 50 GEO	MOTORE
11894	PEUGEOT	95-99	ZENITH 50 N - S	MOTORE
07872	PIAGGIO		VESPA 150 CC. 2%	CARBURATORE
☆ 08853	PIAGGIO	62-64	VESPAGS '62-64 USB/1	MOTORE
☆ 08853/A	PIAGGIO		VESPA SS 180	MOTORE SS 180
08856	PIAGGIO	60-62	VESPA 125	MOTORE E CARBURATORE
08856	PIAGGIO	61-62	VESPA 150	MOTORE E CARBURATORE
08865	PIAGGIO		VESPA 50-90-125 PRIMAVERA	MOTORE
08865	PIAGGIO		VESPA 125 ET3	MOTORE
08865	PIAGGIO		APE 50	MOTORE
08865/A	PIAGGIO		VESPA 125 PRIMAVERA	MOTORE
08865/B	PIAGGIO		VESPA 50-90-125 PRIMAVERA-ET3 (Senza O.R.)	MOTORE
☆ 08883	PIAGGIO		CIAO 2ª SERIE	MOTORE
09865	PIAGGIO	59-64	VESPA 150 SPRINT-GL	MOTORE
09866	PIAGGIO	66	VESPA 150	MOTORE
10867	PIAGGIO		MOTORE CIAO-BOXER BRAVO MONOMARCIA SENZA VARIATORE	MOTORE
10868	PIAGGIO		CIAO-BOXER BRAVO MONOMARCIA CON VARIATORE	MOTORE
10876	PIAGGIO	> 83	PX -125 TS SENZA O.R.	MOTORE
10876/A	PIAGGIO	83 >	VESPA PX	MOTORE
10877	PIAGGIO	> 83	PX FINO ALL'83-125 TS CON O.R.	MOTORE
10877	PIAGGIO		VESPA 125 TS (CON OR)	MOTORE
10895	PIAGGIO		APE P 602 TM - P 703 M	MOTORE
11858	PIAGGIO		APE P 601 LS - CAR LS2 P2 SOLO MOTORE	MOTORE
11867	PIAGGIO	87 >	VESPA PX	MOTORE
11867	PIAGGIO	87 >	VESPA T5	MOTORE
11867	PIAGGIO	87 >	COSA	MOTORE
11872	PIAGGIO		VESPA PX 50 XL	MOTORE
11872	PIAGGIO		VESPA PX 50 FL2	MOTORE
11872	PIAGGIO		VESPA HP 4 M	MOTORE
11872	PIAGGIO		APE 50 TMP	MOTORE
11872/B	PIAGGIO		VESPA PK 50 - XL - FL2	MOTORE
11881	PIAGGIO		GRILLO CON VARIATORE	MOTORE
11883	PIAGGIO		GRILLO MONOMARCIA	MOTORE

Old Codice	Marca	Anno	Modello	Applicazione
11886	PIAGGIO		APE P 501	MOTORE
★ 11886	PIAGGIO	85 >	APE P601 2ª SERIE	MOTORE
11891	PIAGGIO	97	SFERA 50 RST - RESTYLING	MOTORE
11891	PIAGGIO	> 99	FREE BUSINESS - LUSO - PIGMENTATO	MOTORE
11891	PIAGGIO	96 >	NRG	MOTORE
11891	PIAGGIO	95-98	NTT	MOTORE
11891	PIAGGIO	> 96	QUARTZ	MOTORE
11891	PIAGGIO	97	SFERA 50 RST - RESTYLING	MOTORE
11891	PIAGGIO		SFERA 75	MOTORE
11891	PIAGGIO		SFERA 80	MOTORE
11891	PIAGGIO	97-99	VESPA 50 ET 2 - ET 2 INJECTION	MOTORE
11891	PIAGGIO	> 99	ZIP	MOTORE
11891	PIAGGIO	> 97	ZIP FAST RIDER	MOTORE
11891/AE	PIAGGIO		MOTORE (PREZZO ECONOMICO)	MOTORE
12852	PIAGGIO		SCOOTER PIAGGIO TUTTI I MODELLI RAFFREDDATI A LIQUIDO	MOTORE
12852/AE	PIAGGIO		TIPO ECONOMICO SCOOTERS PIAGGIO RAFFREDDATI A LIQUIDO	MOTORE
12854	PIAGGIO	97 >	LIBERTY 50	MOTORE
12855	PIAGGIO	95 >	HEXAGON 125 LX	MOTORE
12855	PIAGGIO	> 97	HEXAGON 150	MOTORE
12856	PIAGGIO	96-97	SFERA RST 125 4 T	MOTORE
12856	PIAGGIO	96-99	VESPA ET4 125	MOTORE
12856	PIAGGIO	> 99	VESPA PX 125	MOTORE
12860	PIAGGIO		ALBERO MOTORE SCOTER 50 (solo 2 pezzi)	MOTORE
11850	PUCH		COBRA	MOTORE
11851	PUCH		50 CC. TUTTI I MODELLI DAL 1979	MOTORE
12851	SPEEDWAY		MOTORE GM DA SPEEDWAY	MOTORE
12850	SUZUKI		ADDRESS AH 50 - RF 50	MOTORE
12850	SUZUKI	> 98	AJ 50 ZZ	MOTORE
12850	SUZUKI	95-98	AP 50	MOTORE
12850	SUZUKI	99 >	AY 50 - W - WR - WRX	MOTORE
12850	SUZUKI	97-98	KATANA 50 - R 50	MOTORE
11878	YAMAHA		YAMAHA XT 600	MOTORE
11895	YAMAHA	99 >	BW'S BUMP	MOTORE
11895	YAMAHA	97-99	BW'S NG ORIGINAL	MOTORE
11895	YAMAHA	95 >	BW'S SPY	MOTORE
11895	YAMAHA	> 96	CT 50 SS	MOTORE
11895	YAMAHA		ZUMA	MOTORE
11896	YAMAHA		JOG 50 R	MOTORE
11896	YAMAHA	95-97	JOG Z	MOTORE
11896	YAMAHA	97 >	NEO'S 50	MOTORE
12853	YAMAHA	97 >	AEROX 50 LC	MOTORE



XNBR

Kits paraolio forcella

Il perfetto funzionamento della forcella anteriore è di fondamentale importanza per qualsiasi tipologia di moto, dal Superbike al Trial.

Ariete ha messo a punto una speciale formulazione di gomma XNBR resistente all'aggressione chimica provocata dagli additivi contenuti negli olii usati nelle forcelle.

È stata inoltre studiata una particolare forma dell'Anello Paraolio che con più labbri di tenuta, rettificati perfettamente, ripartisce e contiene in modo omogeneo la spinta dell'olio impedendo qualsiasi fuoriuscita. La linea di questi kits denominata Ari è

composta da oltre 160 misure diverse che equipaggiano più di 30.000 modelli di moto dagli anni 60 ad oggi. Ogni Kit composto da due anelli di tenuta è dotato di una bustina dello speciale grasso ARISIL studiato e prodotto in USA per le applicazioni gomma-metallo che migliorando il lavoro a cui è sottoposto il paraolio ne aumentano la durata nel tempo.

RICHIEDETE IL CATALOGO SPECIFICO.





Scatola O-RING - Cod. 10934

$\varnothing 3,69 \Rightarrow \varnothing 18,64$

Codice	\varnothing int.	\varnothing corda	Q.ta
00301	3,68	1,78	25
00303	4,48	1,78	25
00304	4,90	1,90	25
00308	6,07	1,78	25
00310	6,75	1,78	25
00312	7,66	1,78	25
00314	8,73	1,78	25
00318	9,13	2,62	25
00319	9,25	1,78	25
00320	9,19	2,62	25
00322	9,92	2,62	25
00324	10,78	2,62	25
00327	11,11	1,78	25
00330	11,91	2,62	25
00332	12,37	2,62	25
00336	13,10	2,62	25
00339	13,95	2,62	25
00341	15,08	2,62	25
00343	15,54	2,62	25
00346	15,88	2,62	25
00349	17,13	2,62	25
00351	17,86	2,62	25
00355	18,72	2,62	25
00356	18,64	3,53	25

O-RING ARIETE

Gli anelli O-RING Ariete sono realizzati con una mescola NBR di durezza 70 Shore A che risponde alle seguenti Norme internazionali:

ASTM D 2000 - SAE J 200 - M2 BG 710 - A14 - B14 - EA14 - EF11 - EF21 - EO14 - EO34 - F15.

Controllo finale secondo AQL 1.

Tolleranze dimensionali DIN 3771/ISO 601

Scatola O-RING - Cod. 10935

$\varnothing 20,22 \Rightarrow \varnothing 46,04$

Codice	\varnothing int.	\varnothing corda	Q.ta
00359	20,22	3,53	20
00360	20,24	2,62	20
00362	20,63	2,62	20
00364	21,82	3,53	20
00367	22,22	2,62	20
00369	23,40	3,53	20
00372	23,81	2,62	20
00374	24,99	3,53	15
00377	25,80	3,53	15
00379	26,58	3,53	15
00383	28,17	3,53	15
00392	31,34	3,53	15
00397	32,93	3,53	15
01302	34,52	3,53	15
01306	36,10	3,53	15
01309	37,47	5,34	8
01310	37,69	3,53	15
01315	39,69	3,53	15
01316	40,65	5,34	8
01320	41,28	3,53	15
01322	42,86	3,53	15
01324	43,82	5,34	7
01328	44,45	3,53	10
01330	46,04	3,53	10

Codice	Rif. Comm.Inglese		Dimensioni		Codice	Rif. Comm.Inglese		Dimensioni	
	Attuale	Precedente	ø Int.	ø Corda		Attuale	Precedente	ø Int.	ø Corda
00301	2015	102	3,68	1,78	00345			15,70	1,30
00302			4,20	1,90	00346	121	121	15,88	2,62
00303	2018	103	4,48	1,78	00347			15,90	3,00
00304			4,90	1,90	00348			16,90	2,70
00305	2021	104	5,28	1,78	00349	3068	122	17,13	2,62
00306			5,70	1,90	00350	2068	123	17,17	1,78
00307			6,00	2,00	00351	123	123	17,86	2,62
00308	2025	105	6,07	1,78	00352			18,30	3,00
00309			6,40	1,90	00353			18,40	2,70
00310	106	106	6,75	1,78	00354			18,30	3,60
00311			7,20	1,90	00355	3075	124	18,72	2,62
00312	2031	107	7,66	1,78	00356	4075	125	18,64	3,53
00313			8,00	1,90	00357	2075		18,77	1,78
00314	108	108	8,73	1,78	00358			19,80	3,60
00316			8,90	2,70	00359	4081	126	20,22	3,53
00317			9,00	2,00	00360	3081	127	20,24	2,62
00318	109	109	9,13	2,62	00361	2081		20,35	1,78
00319	2037	110	9,25	1,78	00362	128	128	20,63	2,62
00320	3037	111	9,19	2,62	00363			21,30	3,60
00322	112	112	9,92	2,62	00364	4087	129	21,82	3,53
00323			10,50	2,70	00365	3087		22,00	2,62
00324	3043	113	10,78	2,62	00366	2087		21,95	1,78
00325	2043		10,82	1,78	00367	130	130	22,22	2,62
00327	114	114	11,11	1,78	00368			23,00	3,60
00328			11,50	4,50	00369	4093	131	23,40	3,53
00329			11,60	2,60	00370	3093		23,47	2,62
00330	115	115	11,91	2,62	00371	2093		23,52	1,78
00332	3050	116	12,37	2,62	00372	132	132	23,81	2,62
00333	2050		12,42	1,78	00373			24,60	3,60
00334			12,50	1,50	00374	4100	133	24,99	3,53
00335			13,00	1,60	00375	3100		25,07	2,62
00336	117	117	13,10	2,62	00376	2100		24,12	1,78
00337			13,60	2,70	00377	134	134	25,80	3,53
00338			13,80	2,20	00378			26,20	3,60
00339	3056	118	13,95	2,62	00379	4106	135	26,58	3,53
00340	2056		14,00	1,78	00380	3106		26,65	2,62
00341	119	119	15,08	2,62	00381	2106		26,70	1,78
00342			15,10	2,70	00382			27,80	3,60
00343	3062	120	15,54	2,62	00383	4112	136	28,17	3,53
00344	2062		15,60	1,78	00384	3112		28,25	2,62

Codice	Rif. Comm.Inglese		Dimensioni	
	Attuale	Precedente	ø Int.	ø Corda
00385	2112		28,30	1,78
00387			29,30	3,60
00388	4118		29,75	3,53
00390	2118		29,87	1,78
00391			30,80	3,60
00392	4125	138	31,34	3,53
00393	3125		31,42	2,62
00394	2125		31,47	1,78
00395			32,00	3,00
00396			32,50	3,60
00397	4131	139	32,93	3,53
00398	3131		32,99	2,62
00399	2131		33,05	1,78
01301			34,10	3,60
01302	4137	140	34,52	3,53
01303	3137		34,60	2,62
01304	2137		34,65	1,78
01305			35,60	3,60
01306	4143	141	36,10	3,53
01307	3143		36,14	2,62
01309	6150	143	37,47	5,34
01310	4150	142	37,69	3,53
01311	3150		37,77	2,62
01312			37,82	1,78

Codice	Rif. Comm.Inglese		Dimensioni	
	Attuale	Precedente	ø Int.	ø Corda
01314	3156		39,34	2,62
01315	144	144	39,69	3,53
01316	6162	145	40,65	5,34
01317	4162		40,86	3,53
01318	3162		40,95	2,62
01319			41,00	1,78
01320	146	146	41,28	3,53
01321	3168		42,52	2,62
01322	147	147	42,86	3,53
01323			43,40	1,50
01324	6175	148	43,82	5,34
01325	4175		44,04	3,53
01326	3175		44,12	2,62
01327			44,17	1,78
01328	149	149	44,45	3,53
01329	3181		45,69	2,62
01330	150	150	46,04	3,53
01331	6187	151	47,00	5,34
01332	4187		47,22	3,53
01333	3187		47,30	2,62
01334			47,35	1,78
01335	152	152	47,63	3,53
01336	3193		48,89	2,62
01337			49,00	1,50
01338	153	153	49,21	3,53

misura	codice	colore	confezione	note
1,5 x 4	11949/10	Nero	10 metri	Sfiato carburatore
	11949/10-T	Trasparente	10 metri	Sfiato carburatore
2 x 5	03998/10	Nero	10 metri	Sfiato carburatore
	03998/10-T	Trasparente	10 metri	Sfiato carburatore
3 x 6	03999/10	Nero	10 metri	Sfiato carburatore
	03999/10-T	Trasparente	10 metri	Sfiato carburatore
4 x 7	01925-V	Verde trasparente	100 metri	tipo economico
	01925/10	Nero	10 metri	tipo economico
	01925/10-V	Verde trasparente	10 metri	tipo economico
	01925/10-S	Viola coestruso	10 metri	per benzina senza piombo
4,5 x 9	01958-V	Verde trasparente	100 metri	tipo economico
	01958/10	Nero	10 metri	tipo economico
	01958/10-V	Verde trasparente	10 metri	tipo economico
4,8 x 9	11922/10-S	Viola coestruso	10 metri	per benzina senza piombo
5 x 8	01922	Nero	100 metri	tipo economico
	01922-V	Verde trasparente	100 metri	tipo economico
	01922/10	Nero	10 metri	tipo economico
	01922/10-V	Verde trasparente	10 metri	tipo economico
5,5 x 10	03904/10	Nero	10 metri	tipo economico
	03904/10-S	Viola coestruso	10 metri	per benzina senza piombo
	03904/10-V	Verde trasparente	10 metri	tipo economico
6 x 9	01958/A	Nero	100 metri	tipo economico
	01958/A-10G	Antracite Polarlys	10 metri	tipo intermedio
	01958/A-V	Verde trasparente	100 metri	tipo economico
	01958/A/10	Nero	10 metri	tipo economico
	01958/A10V	Verde trasparente	10 metri	tipo economico
	01958/A10S	Viola coestruso	10 metri	per benzina senza piombo
	09970/5	Argento coestruso	5 metri	tipo intermedio
6,5 x 11	11923/10-S	Viola coestruso	10 metri	per benzina senza piombo
6 x 13	01902-V	Verde trasparente	50 metri	tipo economico
	01902/10	Nero	10 metri	tipo economico
	01902/10-V	Verde trasparente	10 metri	tipo economico
7 x 10	01922/A	Nero	100 metri	tipo economico
	01922/A-V	Verde trasparente	100 metri	tipo economico
	01922/A/10	Nero	10 metri	tipo economico
	01922/A10V	Verde trasparente	10 metri	tipo economico
8 x 13	11932/10-V	Verde trasparente	10 metri	tipo economico
10 x 15	11934/10-V	Verde trasparente	10 metri	tipo economico

Tubetto raccordo pompa freno-serbatoio liquido DOT4

6x10	12978/5	Nero	5 metri	per liquido DOT4
-------------	---------	------	---------	------------------



are the trademarks of

SANDRO MENTASTI S.R.L.

Via Giovanni Macchi, 30 - Tel. +39 0332 310100 - Fax +39 0332 312632
21100 Varese - Italy

Copyright©
Sandro Mentasti s.r.l.

www.ariete.com - www.mentasti.com - www.oldmodels.it - info@ariete.com

Tutti i diritti riservati. Nessuna parte di questo catalogo può essere riprodotta o utilizzata in alcuna forma o con qualsiasi mezzo, elettronico o meccanico, compresa la fotocopiatura, la registrazione o qualsiasi altro sistema per archiviare o trattenere delle informazioni senza il permesso scritto da parte della Sandro Mentasti S.r.L.

SMQM CODE

CRI	IT	01	14
-----	----	----	----

